

2020

rd rujzdesign



rd rujzdesign

362.21



ŠIFRA ARTIKLA
ARTICLE CODE

OSNA RAZDALJA MED VIJAKI
DISTANCE BETWEEN SCREWS



ALUMINIJ
ALUMINIUM



DOLŽINA
LENGTH



KOVINA
METAL



LES
WOOD



PREMER ENOVIJAČNEGA ROČAJA
SINGLE SCREWED HANDLE DIAMETER



PLASTIKA
PLASTIC



VIŠINA
HEIGHT



STEKLO
GLASS



ŠIRINA
WIDTH



USNJE
LEATHER



DIMENZIJA POGLOBITVE
DEEPENING DIMENSION



PRAVI KARBON
REAL CARBON



GLOBINA POGLOBITVE
DEPTH OF DEEPENING



DOLŽINE PO NAROČILU
CUSTOM LENGTHS



VIŠINA ZUNANJEGA DELA
HEIGHT OF EXTERNAL PART



OSNA RAZDALJA
DISTANCE BETWEEN SCREWS



NASTAVLJIVO PO VIŠINI
HEIGHT-ADJUSTABLE



GLOBINA
DEPTH



ŠIRINA
WIDTH



GLOBINA
DEPTH



VIŠINA
HEIGHT



VIŠINA
HEIGHT



ŠIRINA X DOLŽINA
WIDTH X LENGTH



ŠIRINA X DOLŽINA X VIŠINA
WIDTH X LENGTH X HEIGHT



MATERIAL

ELOKSIRANE POUVRŠINSKE OBDELAVE ANODIZED SURFACE TREATMENTS





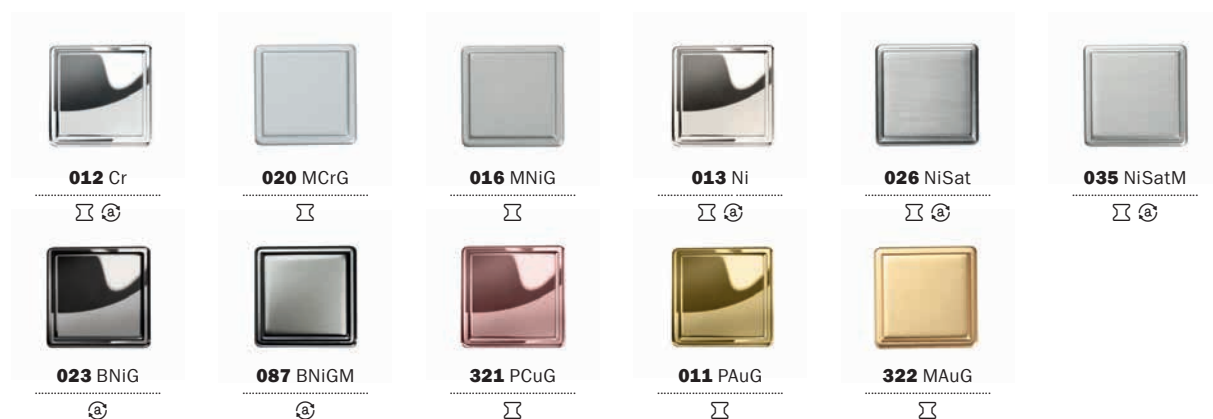

GALVANSKE POUVRŠINSKE OBDELAVE GALVANIC SURFACE TREATMENTS









































LAKIRANE POVRŠINSKE OBDELAVE PAINTED FINISHES



































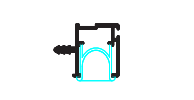
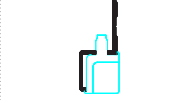
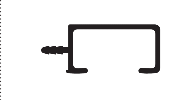
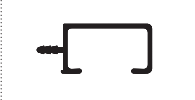



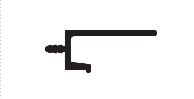
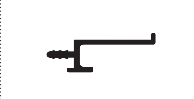

















					
021 MCrL ☞ ☒ ⓐ	032 MCrEL ☞ ☒ ⓐ	089 SatMCrL ☒ ⓐ	017 MNiL ☞ ☒ ⓐ	063 NiL ☞ ☒ ⓐ	062 SNiL ☒ ⓐ
					
029 SatBL ☒ ⓐ	064 TiTL ☞ ☒ ⓐ	311 BNiL ☞ ☒ ⓐ	068 SatBNiL ☒ ⓐ		
					
072 Vint ☒ ⓐ	098 Vint2 ☒ ⓐ	015 MsPatL ☞ ☒ ⓐ	014 BPatL ☞ ☒ ⓐ	028 MAuL ☞ ☒ ⓐ	061 SatAuL ☒ ⓐ
					
306 CuL ☞ ☒ ⓐ	076 SatCuL ☒ ⓐ				
					
024 White ☞ ☒ ⓐ	025 Black ☞ ☒ ⓐ	404 Yellow1 ☞ ☒ ⓐ	407 Orange1 ☞ ☒ ⓐ	408 Orange2 ☞ ☒ ⓐ	409 Beige ☞ ☒ ⓐ
					
410 Red1 ☞ ☒ ⓐ	412 Pink ☞ ☒ ⓐ	416 Blue ☞ ☒ ⓐ	421 Green2 ☞ ☒ ⓐ	423 Green4 ☞ ☒ ⓐ	452 Grey1 ☞ ☒ ⓐ
					
491 Barby Violet ☞ ☒ ⓐ	490 Barby Yellow ☞ ☒ ⓐ	488 Barby Green ☞ ☒ ⓐ	489 Barby Blue ☞ ☒ ⓐ		

NAJPOMEMBNEJŠE VRSTE LESA IN NJIHOVE POVRŠINSKE OBDELAVE MOST IMPORTANT WOODS AND WOODEN FINISHES

				
215 Oak ⚠	189 Oak Wenge ⚠	102 Beech Natur ⚠	105 Beech Toned P ⚠	240 Wallnut Natur ⚠

IZDELKI IZ ALUMINIJA ALUMINIUM PRODUCTS

 520.20 / 022	 520.28 / 022	 595.28 / 023	 595.28B / 023	 574.10 / 023	 573.20 / 023
 618.15 / 025	 653.15 / 025	 620.20 / 024	 614.16 / 024	 634.10 / 024	 651.24 / 025
 619.10 / 025	 648.17 / 030	 646.32 / 026	 611.08 / 026	 612.08 / 026	 525.27 / 027
 632.27B / 027	 678.12 / 027	 675.25 / 028	 617.33 / 028	 642.20 / 028	 644.16 / 029
 581.28 / 029	 528.02 / 029	 513.10B / 030	 355.15 / 030	 553.28 / 030	 424.29 / 031
 426.25 / 031	 534.25 / 031	 631.22A / 032	 631.22B / 032	 673.22 / 032	 638.27B / 031
 683.15 / 033	 682.15 / 033	 550.10 / 034	 627.10 / 034	 546.12 / 034	 546.12B / 034
 476.15 / 035	 347.20 / 035	 369.16 / 035	 570.80 / 036	 570.60 / 036	 570.40 / 036
 561.20 / 036	 341.13 / 037	 341.10 / 037	 640.10 / 037	 208.10 / 038	 208.10B / 038
 208.10C / 038	 624.12BL / 038	 624.12CL / 038	 679.12L / 038	 242.13 / 038	 242.13B / 038

 242.13C / 038	 285.13 / 039	 404.16B / 039	 404.16 / 039	 572.35 / 039	 328.20B / 040
 567.19 / 040	 490.17 / 040	 613.27B / 041	 427.27 / 041	 670.20 / 041	 357.25 / 042
 375.24 / 042	 390.25 / 042	 374.21 / 043	 410.20 / 043	 333.08 / 043	 531.24 / 044
 576.28 / 044	 327.24 / 044	 693.20 / 033	 688.12 / 037	 692.18 / 084	 691.26 / 093
PROFILI ZA OMARE WARDROBE PROFILES	 2168 / 045	 2169 / 045	 401.40 / 046	 452.21 / 046	 345.18 / 046
 2198B / 046	 2198A / 046	 2139 / 046	 326.15B / 046	 2159B / 046	 2159A / 046
 2159D / 063	 2197B / 046	 2197A / 046	 2197 / 046	 325.37 / 047	 464.35 / 047
 555.95 / 047	 2192 / 047	 658.35 / 047	 466.43 / 047	 643.33 / 047	 606.40 / 047
 444.25 / 047	 2107 / 047	 552.15 / 047	 VZ12.002A / 058	 690.16 / 066	
ROČAJI ZA OMARE WARDROBE HANDLES	 665.12 / 049	 546.12 / 049	 525.27 / 049	 561.20 / 049	 568.28 / 049
KRIVLJENI ROČAJI IZ ALUMINIJA CURVED ALUMINIUM HANDLES	 520.20C / 051	 574.10C / 051	 632.27BC / 051		

ROČAJI
ZA KOPALNICE
BATHROOM HANDLES



616.08 / 052



616.08B / 052



2188 / 053



2109A / 053



2144 / 053



2189 / 053

VGRADNI &
UTOPNI ROČAJI
INTEGRATED &
EMBEDDED HANDLES



555.95 / 055



2217 / 055



2141 / 055



2192 / 056



2222 / 056



2192B / 056



2222B / 056



2192C / 056



2222C / 056



2192D / 057



2222D / 057



398.37 / 057



464.35 / 057



2118 / 057



656.35 / 058



643.33 / 058



649.35 / 058



658.35 / 059



466.43 / 059



606.40 / 059



401.40 / 060

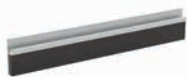

345.18 / 060



2139 / 060



455.18 / 061



433.21 / 061



452.21 / 061



326.15 / 062



326.15B / 062



326.15L+(D) / 062



2159A / 063



2159B / 063



2159C / 063



2198A / 063



2198B / 063



2197A / 064



2197B / 064



2197 / 064



441.97 / 064



2142 / 065



U11/14 / 065



586.14 / 065



2171 / 066



2171L+(R) / 066



10.001B / 066



674.15 / 067



674.15B / 067



10.001 / 067



675.25 / 068



675.25B / 068



675.25CL (R) / 068









































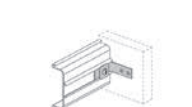

609.18 / 069

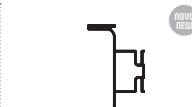

609.18D / 069

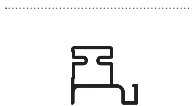

437.20 / 069

 615.13 / 070	 435.30 / 070	 403.07 / 070	 U12AC / 071	 U12AE / 071	 U12BC / 071
 U12BE / 071	 U11.001/35 / 071	 U11.001/50 / 071	 U6.137/45 / 072	 U6.56/45 / 072	 U7.180/40 / 072
 U9.175/55 / 072	 U9.41/41 / 072	 VZ12.02A / 058	 2195D / 063	 690.16 / 066	 690.16 / 066
GOLA PROFILI GOLA PROFILES	 2199L / 074	 2199C / 074	 2199C.F / 074	 2199L.F / 074	 2199C.E / 074
 2199L.E / 074	 2199L.I / 074	 2199L.O / 074	 2199C.OS / 072	 2199C.IS / 074	 2199L.OS / 074
 2199L.IS / 074	 2199K / 074	 2199T-18/T-19 / 074	 2199P / 074	 2200L / 075	 2200C / 075
 2146 / 075	 2147 / 075				
CUBUS PROFILNI SISTEMI CUBUS PROFILE SYSTEM	 60.001 / 077				
ZAŠČITNI DRSNIKI LUGGAGE RACK BARS	 80.001 / 079	 80.002 / 079	 80.003 / 079		

KOVINSKI ROČAJI IN GUMBI METAL HANDLES AND KNOBS

 590.01 / 082	 590.02 / 082	 590.03 / 082	 501.10 / 082	 500.10 / 082	 502.10 / 082
--	--	--	--	---	--



528.03 / 082



557.02 / 083



557.04 / 083



557.01 / 083



557.03 / 083



437.20 / 083



580.26 / 084



836.26 / 084



580.26sw / 084



588.25 / 084



587.25 / 085



604.27 / 085



569.28 / 085



832.28 / 085



667.20 / 086



668.15 / 086



669.15 / 086



354.25 / 087



685.10 / 087

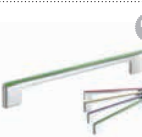

677.08 / 087



415.26R / 088



495.25 / 088



529.27 / 088



516.30 / 089



826.30 / 089



516.30B / 089



826.30B / 089



516.30E / 089



826.30E / 089



446.24R / 090



447.20R / 090



497.22 / 090



360.28 / 091



367.20 / 091



496.14 / 091



603.29 / 091



361.25 / 092



362.21 / 092



462.25 / 092



362.21A / 092



396.25 / 092



362.21D / 092



498.16 / 093



536.16 / 093



527.13 / 093



527.13B / 093



691.26 / 093



370.30 / 094



387.20 / 094



386.20 / 094



311.20 / 094



219.08 / 095



219.10 / 095



304.16 / 095



583.19 / 095



692.18 / 095



807.24 / 096



199.15 / 096



199.15D / 096



805.13 / 096



836.26 / 096



194.20 / 096



823.18 / 096



































































510.34 / 096



454.20 / 096

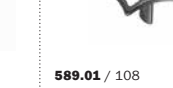

584.19 / 096

				 NOVO NEU	 NOVO NEU
834.11 / 097	832.28 / 097	803.25 / 097	825.32 / 097	652.20 / 097	653.15 / 097
					
833.20 / 097	850.40 / 097	613.27B / 097	567.19 / 097	328.20B / 097	564.27 / 097
					
667.20 / 098	851.30 / 098	163.26 / 098	809.24 / 098	367.20 / 098	311.20 / 098
					
819.32 / 098	804.15 / 098	362.21C / 098	362.21B / 098	826.30D / 098	826.30B / 098
					
170.18 / 099	161.19 / 099	162.24 / 099	MS 7.25 / 099	MS 5.20 / 099	MS 5.25 / 099
					
MS 3.28 / 099	MS 4.28 / 099	MS 6.38 / 099	MS 6.32 / 099	MS 6.25 / 099	160.12 / 096
VINTAGE VINTAGE					
	630.15 / 101	636.15 / 101	657.16 / 101	650.12 / 102	667.20 / 102
					
347.20 / 102	354.25 / 103	516.30C / 103	826.30C / 103	590.01 / 103	590.02 / 103
					
590.03 / 103	651.24 / 104	668.15 / 104	619.10 / 104	387.20 / 105	386.20 / 105
					 NOVO NEU
583.19 / 105	561.20 / 106	415.26R / 106	529.27 / 106	613.27B / 107	555.95 / 107
					
U9.41/41 / 107	U9.175/55 / 107	454.20 / 108	199.15D / 108	851.30 / 108	589.01 / 108

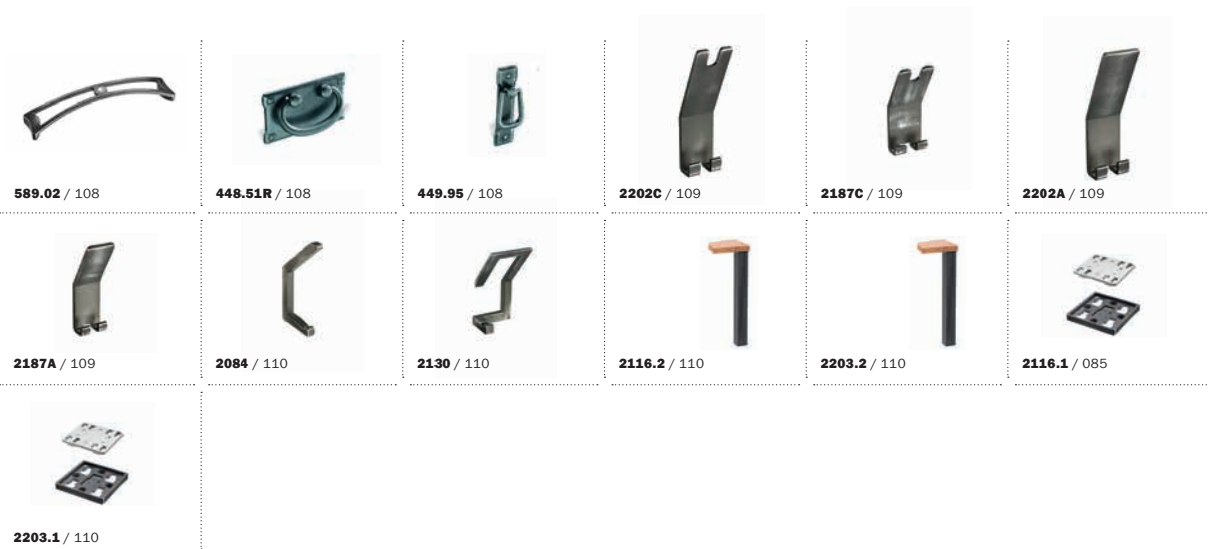



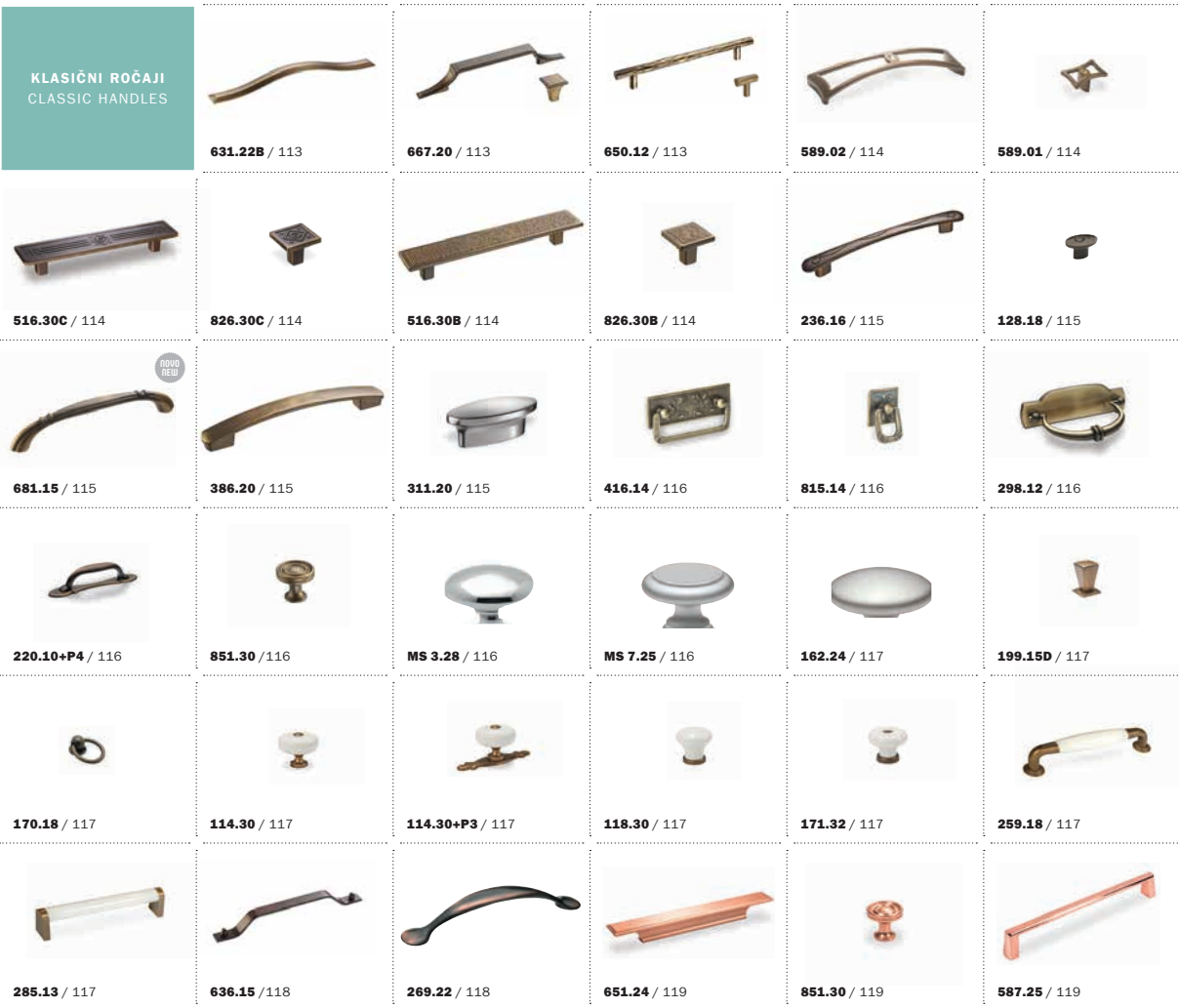



































KLASIČNI ROČAJI
CLASSIC HANDLES





































































ROČAJI IN GUMBI IZ LESA
WOODEN HANDLES AND KNOBS



					
539.01A / 123	539.02A / 123	539.03A / 123	556.10 / 124	830.10 / 124	382.42 / 124
					
493.35 / 124	350.43 / 125	258.28 / 125	308.22 / 125	476.15 / 126	541.15 / 126
					
237.13 / 126	285.13 / 126	259.18 / 126	204.16 / 126	213.14 / 126	221.10 / 126
					
U1.150 / 127	U3.150 / 127	U2.150 / 127	U2.140 / 127	U2.135 / 127	114.30 / 127
					
114.30+P3 / 127	118.30 / 127	810.18 / 128	132.25D / 128	149.35 / 128	811.34 / 128
					
124.27 / 128	135.30 / 128	144.32 / 128	145.28 / 128	171.32 / 128	L1.03.32 / 128
					
L1.04.35 / 128	L1.05.36 / 128				

PLASTIČNI ROČAJI / USNjeni ROČAJI
PLASTIC HANDLES / LEATHER HANDLES

					
154.40 / 132	816.70 / 132	842.30 / 132	847.24 / 132	155.40 / 132	277.32 / 132
					
472.52 / 132	469.50 / 132	470.50 / 132	471.55 / 132	506.32 / 132	601.26 / 132
					
843.22 / 133	844.24 / 133	845.27 / 133	846.25 / 133	169.30 / 133	117.30 / 133

 106.14 / 133	 104.14 / 133	 109.20 / 133	 132.25D / 133	 124.27 / 133	 172.39 / 133
 600.01 / 134	 600.02 / 134	 600.03 / 134	 600.04 / 134	 600.05 / 134	 600.06 / 134
 600.07 / 134	 600.08 / 134	 600.09 / 134	 600.00 / 134	 828.40 / 135	 829.100 / 135
 596.22 / 135	 597.22 / 135	 598.32 / 135	 599.30 / 135	 530.24 / 135	 302.20 / 135
 222.13 / 136	 228.10 / 136	 285.13 / 136	 U2.150 / 136	 331.16 / 136	 801.16 / 136
 118.30 / 136	 114.30 / 136	 171.32 / 136	 241.08 / 137	 299.08 / 137	 2153 / 137
 2154 / 137	 2155 / 137	 2156 / 137	 2157 / 137		
 USNJNI ROČAJI LEATHER HANDLES	 591.15 / 138	 592.15 / 138	 516.30F / 138	 826.30F / 138	 322.16 / 139
	 577.19 / 139	 855.25 / 139	 157.16 / 139		

OBEŠALNIKI HOOKS

 2123 / 142	 2124 / 142	 2130 / 142	 2084 / 142	 2187A / 143	 2202A / 143
---	---	---	---	---	--

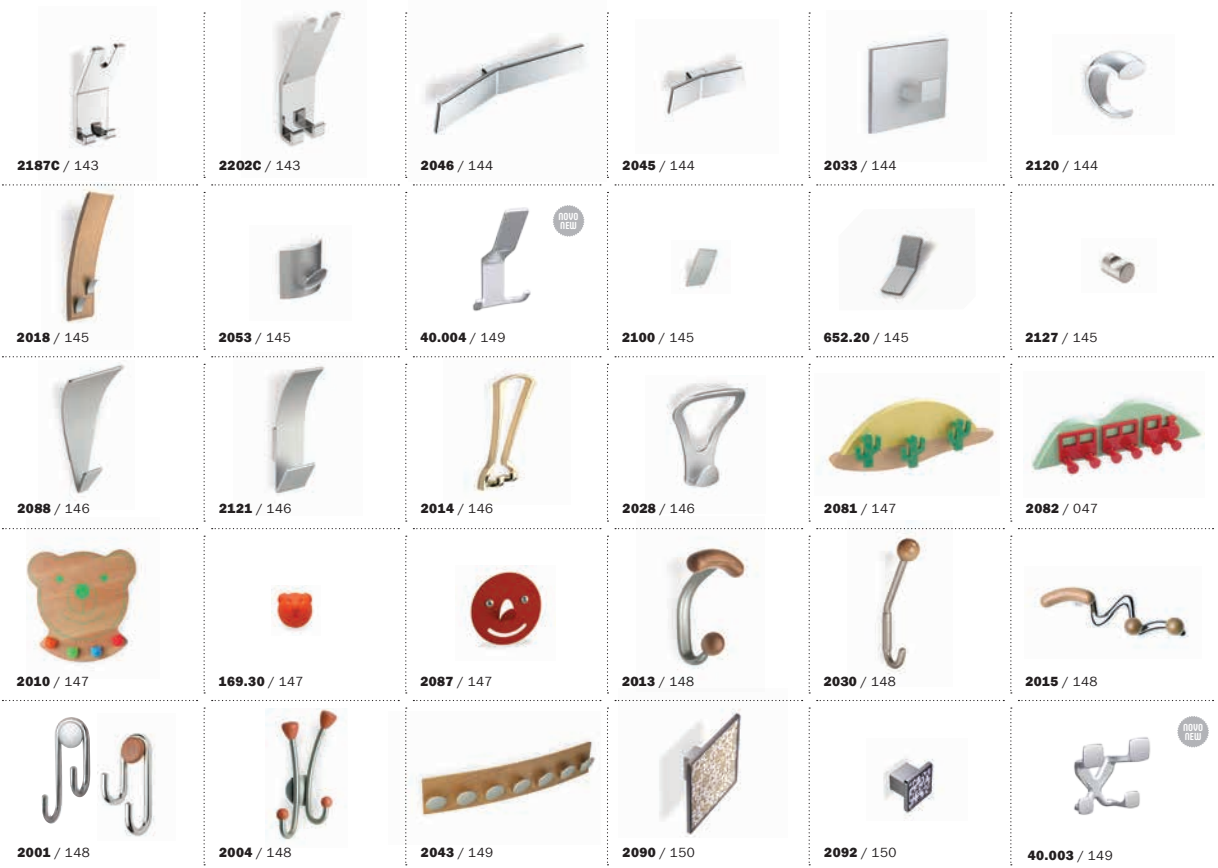

NOGE
LEGS



POSEBNI PROJEKTI
SPECIAL PROJECTS

ART.	STRAN/PAGE
10.001	67
104.14	133
106.14	133
109.20	133
10.001	67
10.001B	66
114.30	117, 127, 136
114.30+P3	117, 127
117.30	133
118.30	117, 127, 136
12.002A	58
124.27	128, 133
128.18	115
132.25D	128, 133
135.30	128
144.32	128
145.28	128
149.35	128
154.40	132
155.40	132
157.16	139
160.12	96
161.19	99
162.24	99, 117
163.26	98
166.10	123
169.30	133, 147
170.18	99, 117
171.32	117, 128, 136
172.39	133
194.20	96
199.15	96
199.15D	96, 108, 117
2001	148
2004	148
2014	146
2017	155
2018	145
2010	147
2013	148
2015	148
2028	146
2033	144
2037	145
2030	148
2045	144
2046	144
204.16	126
2043	149
2053	145
2057	155
2059	155
2062	155
2064	154
2066	154
2067	154
2070	154
2072	155
2073	154
2084	110, 142
2088	146
208.10	38
208.10B	38
208.10C	38
2081	147
2082	147
2087	147
2090	150
2092	150
2100	145
2107	47
2109A	53
2118	57
2116.1	110
2116.2	110
2120	144
2121	146
2123	142
2124	142

ART.	STRAN/PAGE
2127	145
2130	110, 142
2139	46, 60
213.14	126
2141	55
2142	65
2146	75
2147	75
2144	53
2150	154
2151	155
2152	155
2158	154
2153	137
2154	137
2155	137
2156	137
2157	137
2159A	46, 63
2159B	46, 63
2159C	46, 63
2159D	46, 63
2168	45
2169	45
2171	66
2171L+(R)	66
2178R	154
2184B	154
2187A	109, 143
2187C	109, 143
2188	53
2189	53
2192	47, 56
2197	46, 64
219.08	95
219.10	95
2192B	56
2192C	56
2192D	57
2197A	46, 64
2197B	46, 64
2198A	46, 63
2198B	46, 63
2199C	74
2199C.E	74
2199C.F	74
2199C.IS	74
2199C.OS	74
2199K	74
2199L	74
2199L.E	74
2199L.F	74
2199L.I	74
2199L.IS	74
2199L.O	74
2199L.OS	74
2199P	74
2199T-18/T-19	74
220.10+P4	116
2200C	75
2200L	75
2202A	109, 143
2202C	109, 143
2203.1	110
2203.2	110
2217	55
221.10	126
2222	56
222.13	136
2222B	56
2222C	56
2222D	57
228.10	136
236.16	115
237.13	126
241.08	137
242.13	38
242.13B	38
242.13C	38

ART.	STRAN/PAGE
258.28	125
259.18	117, 126
269.22	118
277.32	132
285.13	39, 117, 126, 136
289.26	123
298.12	116
299.08	137
3002	155
302.20	135
304.16	95
308.22	125
30.001	78
311.20	94, 98, 115
322.16	139
325.37	47
326.15	62
326.15B	46, 62
326.15L+(D)	62
327.24	44
328.20B	40, 97
331.16	136
333.08	43
341.10	37
341.13	37
345.18	46, 60
347.20	35, 102, 122
350.43	125
354.25	87, 103
355.15	30
357.25	42
360.28	91
361.25	92
362.21	92
362.21A	92
362.21B	98
362.21C	98
362.21D	92
367.20	91, 98
369.16	35
370.30	94
374.21	43
375.24	42
382.42	124
386.20	94, 105, 115
387.20	94, 105
390.25	42
396.25	92
398.37	57
40.003	149
40.004	149
401.40	46, 60
403.07	70
404.16	39
404.16B	39
410.20	43
414.14	122
415.26R	88, 106
416.14	116
424.29	31
426.25	31
427.27	41
433.21	61
435.30	70
437.20	69, 83
441.97	64
444.25	47
445.25	47
446.24R	90
447.20R	90
448.51R	108
449.95	108
452.21	46, 61
454.20	96, 108
455.18	61
462.25	92
464.35	47, 57
466.43	47, 59
469.50	132

ART.	STRAN/PAGE
470.50	132
471.55	132
475.52	132
476.15	35,126
490.17	40
493.35	124
495.25	88
496.14	91
497.22	90
498.16	93
500.10	82
501.10	82
502.10	82
506.32	132
510.34	96
513.10B	30
516.30	89
516.30B	89,114
516.30C	103,114
516.30E	89
516.30F	138
520.15	22
520.20	22
520.20C	51
520.28	22
525.27	27,49
527.13	93
527.13B	93
528.01	123
528.02	29
528.03	82
529.27	88,106
530.24	135
531.24	44
534.25	31
536.16	93
539.01A	123
539.02A	123
539.03A	123
541.15	126
546.12	34,49
546.12B	34
550.10	34
552.15	47
553.28	30
555.95	47,55,107
556.10	124
557.01	83
557.02	83
557.03	83
557.04	83
561.20	36,49,106
564.27	97
567.19	40,97
568.28	49
569.28	85
570.40	36
570.60	36
570.80	36
572.35	39
573.20	23
574.10	23
574.10C	51
576.28	44
577.19	139
580.26	84
580.26sw	84
581.28	29
583.19	95,105
584.19	96
586.14	65
587.25	85,119
588.25	84
589.01	108,114
589.02	108,114
590.01	82,103
590.02	82,103
590.03	82,103
595.28	23

ART.	STRAN/PAGE
591.15	138
592.15	138
595.28B	23
596.22	135
597.22	135
598.32	135
599.30	135
600.00	134
600.01	134
600.02	134
600.03	134
600.04	134
600.05	134
600.06	134
600.07	134
600.08	134
600.09	134
601.26	132
603.29	91
604.27	85
606.40	47,59
609.18	69
609.18D	69
60.001	77
611.08	26
612.08	26
613.27B	41,97,107,122
614.16	24
615.13	70
616.08	52
616.08B	52
617.33	28
618.15	25
619.10	25,104
620.20	24
624.12BL	38
624.12CL	38
627.10	34
630.15	101
631.22A	32
631.22B	32,113
632.27B	27
632.27BC	51
634.10	24
636.15	101,118
638.27B	31
639.20	33
640.10	37
642.20	28
643.33	47,58
644.16	29
646.32	26
648.17	30
650.12	102,113
651.24	25,104,119
652.20	97,145
653.15	23,97
656.35	58
657.16	101
658.35	47,59
665.12	49
667.20	86,98,102,113
668.15	86,104
669.15	86
670.20	41
673.22	32
674.15	67
674.15B	67
675.25	28,68
675.25B	68
675.25CL (R)	68
677.08	87
678.12	27
679.12L	38
681.15	115
682.15	33
683.15	33
684.12	48
685.10	87

ART.	STRAN/PAGE
688.12	37
690.16	66
691.26	93
692.18	84
801.16	136
803.25	97
804.15	98
805.13	96
807.24	96
809.24	98
80.001	79
80.002	79
80.003	79
810.18	128
811.34	128
815.14	116
816.70	132
819.32	98
823.18	96
825.32	97
826.30	89
826.30B	89,98,114
826.30C	103,114
826.30D	98
826.30E	89
826.30F	138
828.40	135
829.100	135
830.10	124
832.28	85,97
833.20	97
834.11	97
836.26	84,96
842.30	132
843.22	133
844.24	133
845.27	133
846.25	133
847.24	132
850.40	97
851.30	98,108,116,119
855.25	139
L1.03.32	128
L1.04.35	128
L1.05.36	128
MS 2116.1	156,157
MS 2203.1	156,157,158
MS 3.28	99,116
MS 4.28	99
MS 5.20	99
MS 5.25	99
MS 6.25	99
MS 6.32	99
MS 6.38	99
MS 7.25	99,116
NG 2116.2A	156,157,158
NG 2116.2L	157,158
NG 2203.2A	156,157
NG 2203.2L	157
PPS 2116.5	157,158
PS 2203.5	157,158
TA 2090-92 SET	150
U1.150	127
U11.001/35	71
U11.001/50	71
U11/14	65
U12AC	71
U12AE	71
U12BC	71
U12BE	71
U2.135	127
U2.140	127
U2.150	127,136
U3.150	127
U6.137/45	72
U6.56/45	72
U7.180/40	72
U9.175/55	72,107
U9.41/41	72,107



IZDELKI IZ ALUMINIJA



ALUMINIUM PRODUCTS

520.28

	160	224	256	320	416			26
	167	231	263	327	423			28

520.20

	128	160	224	270	320	370	416	470	620			26
	135	167	231	277	327	377	423	477	627			20

 NOVO
 NEW

520.15

	128	160	224	320	416			26
	135	167	231	327	423			15



574.10



	128	160	224	320	416			32
	138	170	234	330	426			10



573.20



	128	160	224	256	320	416	480			32
	135	167	231	263	327	423	487			20



595.28



	96	256	352			30
	120	300	400			28



595.28B



	96	
	155	
	30	
	28	

620.20

160

192

256

270

320

370

416

470

620



29



186

218

282

296

346

396

442

496

646



20

614.16

160

175

224

275

320

325

375

416

425

475

512

620



35



186

201

250

301

346

351

401

442

451

501

538

646



16

634.10

128

160

224

256

320

416

470



29



150

182

246

278

342

438

492



10



651.24



	32	96	160	(X)		20
	110	180	250	(LX)		24



619.10



	160	270	370	(X)		36
	197	307	407	(LX)		10



618.15



	96	160	192	(X)		25
	155	211	287	(LX)		15



653.15



	16	(X)
	35	(LX)
	25	
	15	

646.32

	160	210	260	310	360	460			32
	172	222	272	322	372	472			12

611.08

	32	96	160	224	320	2x224	2x320	2x416			28
	96	224	288	352	448	576	768	960			8

612.08

	64	160	224	320	2x224	2x320	2x416			31
	79	175	239	335	463	655	847			10



525.27



	32	128	160	192	224	256	288	3x192	3x256	2x400			27
	66	175	240	275	325	375	475	675	875	1100			7



632.27B



	160	224	320	416			27
	200	260	360	460			7

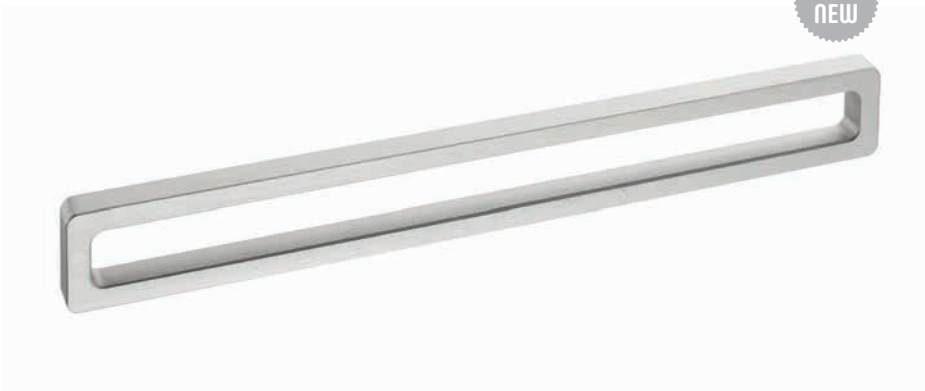

NOVO
NEW

678.12

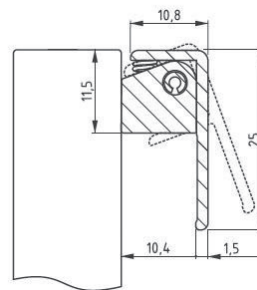
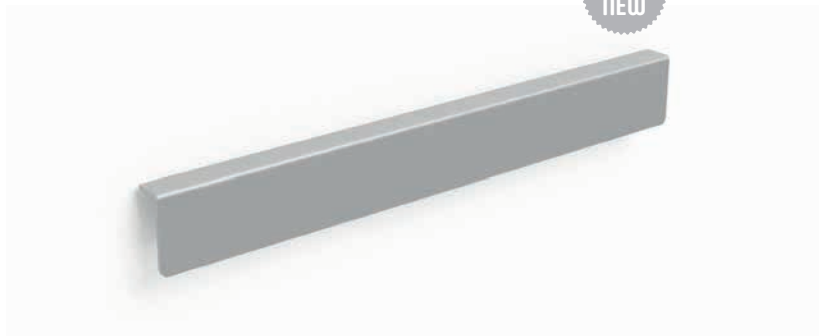

	160	224	256	320	480			35
	280	330	380	480	580			12

NOVO
 NEW

675.25

	32	32	106(170)	156(220)	206(270)	256(320)	306(370)	256(420)			25
	60	147	197	247	297	347	397	447			11
	406(470)	456(520)	506(570)	606(670)	706(770)	806(870)	906(970)	1106(1170)			25
	497	547	597	697	797	897	997	1197			11

617.33

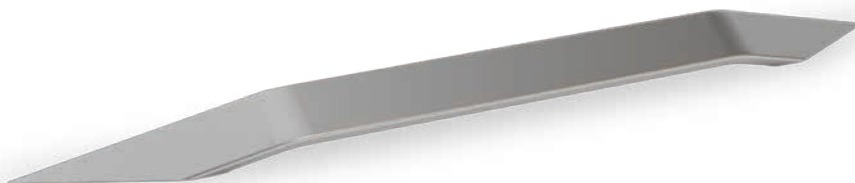
	160	224	320	416			30
	167	231	327	423			33

642.20

	160	192	256	270	370	416	470			28
	232	264	328	342	442	488	542			20



644.16



	128	160	224	270	320	370	420	470	570	670	770	870			32
	141	173	237	283	333	383	433	483	583	683	783	883			16



581.28



	128	160	224	320	416	480			30
	136	168	232	328	424	488			28



528.02



	224	320	420	520			28
	233	329	429	529			40

**648.17**

128

160

224

320

416



17



160

210

260

360

460



30

**513.10B**

192

224

416



29

35

37



204

233

430



10

**355.15**

192

512



40

52



230

570



22

22

**553.28**

224

384



24

34



239

405



28



638.27B



	160	224		27
	177	239		13



424.29



	128	170	192	220	270	320	370	470			29
	143	185	207	235	285	335	385	485			17

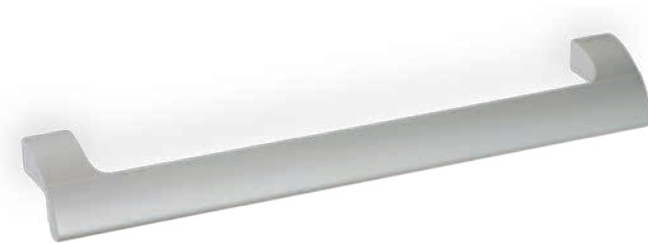

426.25



	128	170	192	220	270	320	370	470			25
	143	185	207	235	285	335	385	485			24



534.25



	170	270	320	370	470	620			23
	200	300	350	400	500	650			23

631.22A

160

256

384



25



212

340

470



22

631.22B

192

288

416



29



215

340

465



22

 NOVO
 NEW

673.22

160

192

224

320

416



29



182

214

246

342

438



22

NOVO
NEW

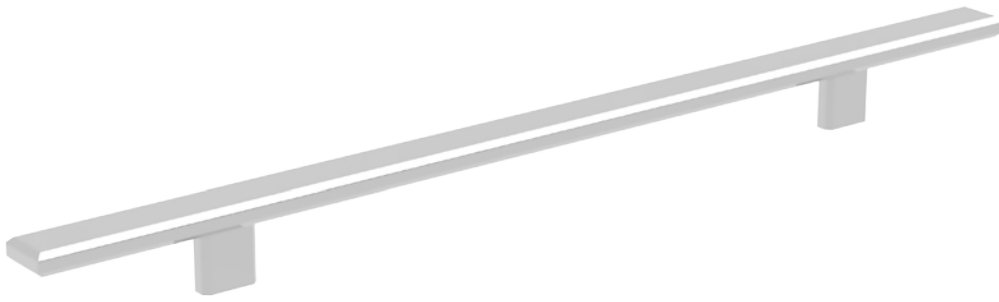

693.20



	10	120	150	170	270	370	470	570	770			28
	100	200	250	300	400	500	600	700	900			20

NOVO
NEW

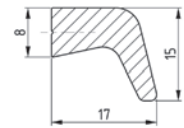

683.15



	32	128	192	224	256	320	448	512	640			17
	90	190	290	340	390	490	590	690	790			15

NOVO
NEW

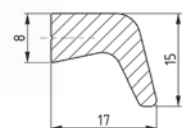

682.15



	64	160	224	256	320	416	488	576	672			17
	97	197	297	347	397	497	597	697	797			15

550.10

128 | 160 | 192 | 224 | 320 | 416 | 480



34



138 | 170 | 202 | 234 | 330 | 426 | 490



10

627.10

128 | 184 | 284 | 334 | 384 | 484 | 2x342 | 2x392 | 2x442 | 2x542



32



138 | 194 | 294 | 344 | 394 | 494 | 694 | 794 | 894 | 1094



10

546.12

546.12B
546.12 / B

128 | 160 | 192 | 224 | 320 | 416 | 512 | 608 | 800 | 992



33



140 | 172 | 204 | 236 | 332 | 428 | 524 | 620 | 812 | 1004



12



476.15



	170	270	320	370	470			38
	181	281	331	381	481			15



347.20



	160	224	305	355	416	505			30
	170	234	315	365	426	515			20



369.16

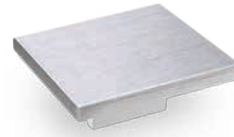
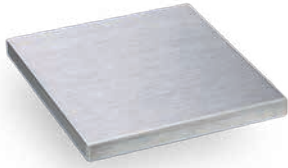

	128	170	270	320	370	470	670	770	870	1070			37
	153	195	295	345	395	495	695	795	895	1095			16

570.80

	32		26
	80		80

570.60

	16		26
	60		60

570.40

	16	32	96	128	160	224	288	320	352			26
	40	70	142	192	242	292	342	392	492			40

561.20

	1	64	110	160	210	260	360	560	660	760	960			29
	100	164	210	260	310	360	460	660	760	860	1060			20





341.13



	128	160	256	384	512			43
	141	173	269	397	525			13

341.10



	128	160	256	384			32
	138	170	266	394			10



640.10



	160	224	320	416	480			30
	170	234	330	426	490			10

NOVO
NEW

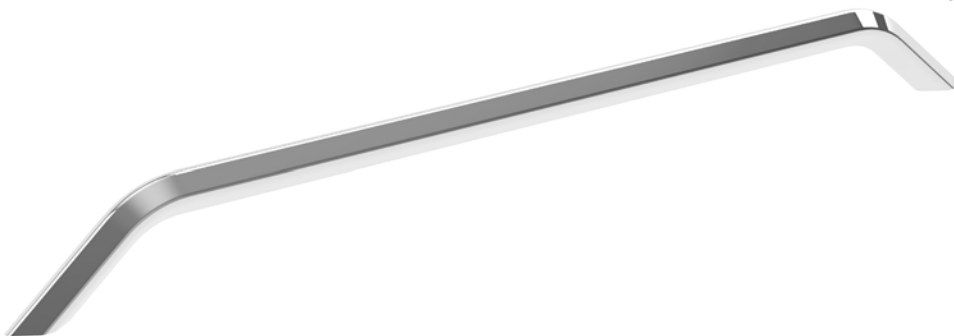

688.12



	160	224	320	416	512	620			33
	185	249	345	441	537	645			12



208.10 / B / C		64	96	128	160	192	224	320	416	608	800	992			29	30	32
		100	134	178	210	242	274	370	466	658	850	1042			10		



624.12BL / CL		128	160	192	224	256	288	384	480	576	672			34
		178	210	242	274	306	338	434	530	626	722			12
679.12L		128	160	192	224	256	288	384	480	576	672			34
		168	200	232	264	296	328	424	520	616	712			12



242.13 / B / C		128	160	192	256	352	512	704	928			31	33	34
		178	210	242	306	402	562	754	978			13		



285.13 		96	128	192	320			31
		103	135	199	327			



404.16 		41	404.16B 		36
		16			16

404.16 / B 		128	160	256	352	448	544	768	1056	
		178	210	306	402	498	594	818	1106	

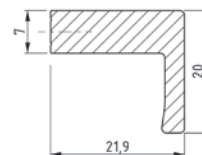

572.35 		128	160	192	256	320	480	640	800			35
		148	180	212	276	340	500	660	820			

328.20B

	1	96	128	160	192	224	320	416	512	672	736	800			22
	20	120	178	210	242	295	395	495	595	695	795	895			20

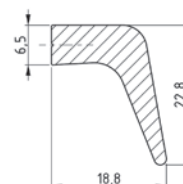
567.19

	1	32	64	128	160	224	320	416	544			23
	20	40	95	145	180	295	395	495	795			19

490.17

	1	128	160	224	320	416	2x336			17
	20	178	210	295	360	495	695			10

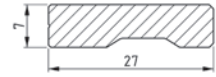
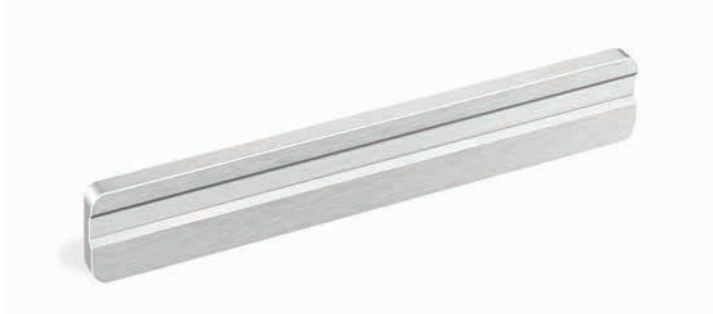

613.27B



	16	128	160	224	320	(X)		27
	32	160	224	320	416	(LX)		7

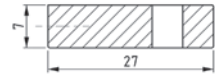
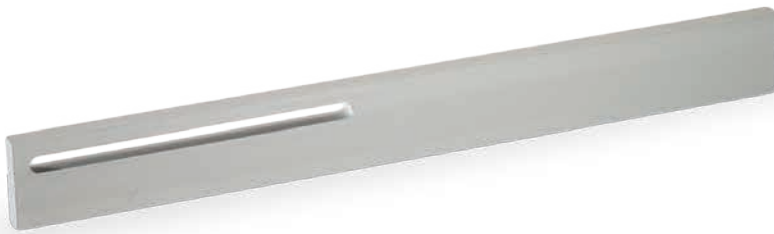

427.27



	96	128	160	(X)		27
	150	200	250	(LX)		7

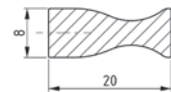

670.20

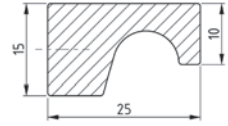

	64	(X)		20
	80	(LX)		8

357.25

224

320

400

2x288

2x352

2x384



25



250

383

500

600

788

833

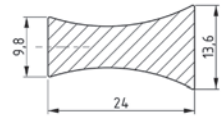
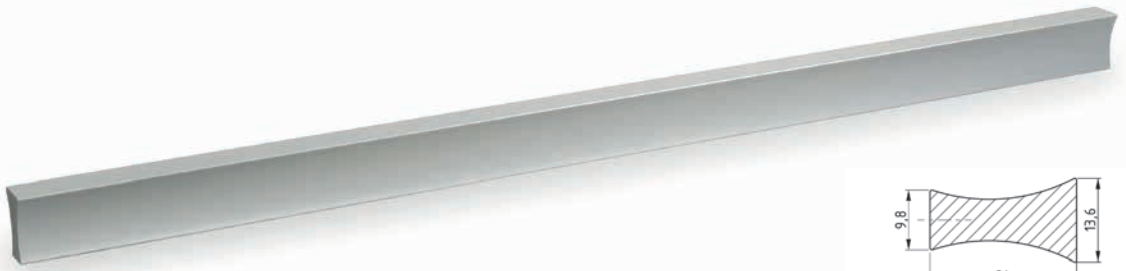

15

375.24

32

64

96

128

160

192

320



24



52

82

114

148

178

210

338

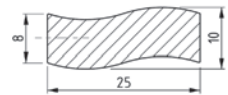
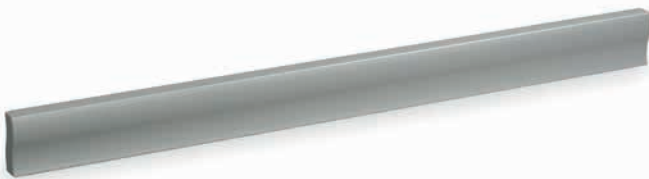

14

390.25

32

96

160

192

288

512



25



40

114

178

210

306

668



10

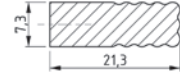

374.21



	96	128	160	192	320	512	608	800			21
	114	146	178	210	466	668	860	1052			7

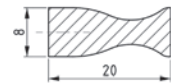

410.20



	32	64	96	128	160	192	288	2x400	2x448	2x480			20
	52	82	114	168	210	242	328	854	954	1000			8

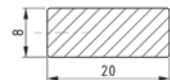
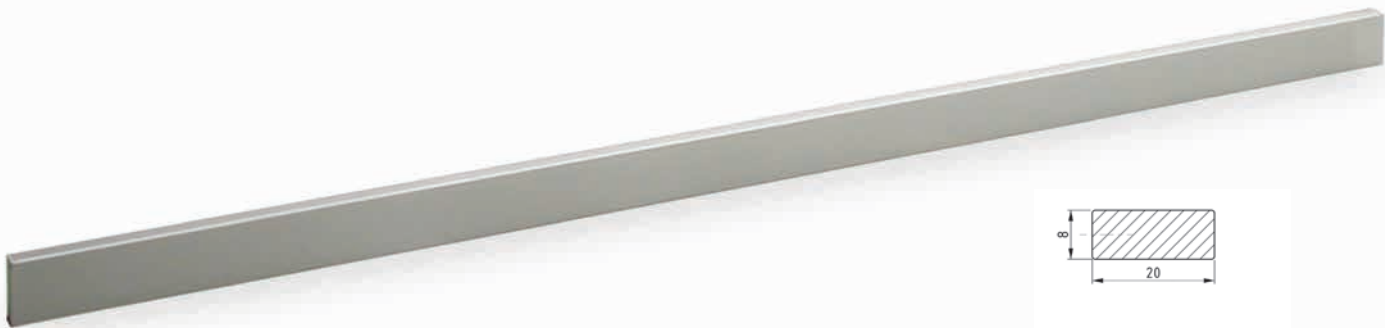

333.08



	1	96	128	160	256	320	512	608	800			20
	30	105	168	242	370	466	688	860	1052			8

531.24

	32	64	160	192	2x112	2x144	2x160	2x208	2x192	2x272	2x400			24
	52	85	200	255	300	350	400	500	565	800	1100			8

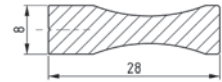

576.28

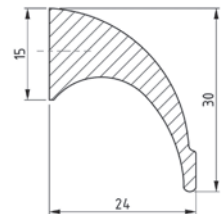
	64	2x96	224	2x192	2x448			28
	84	250	300	450	1020			8

327.24

	128	160	224	320	416	512	608			30
	150	210	295	395	495	595	695			24

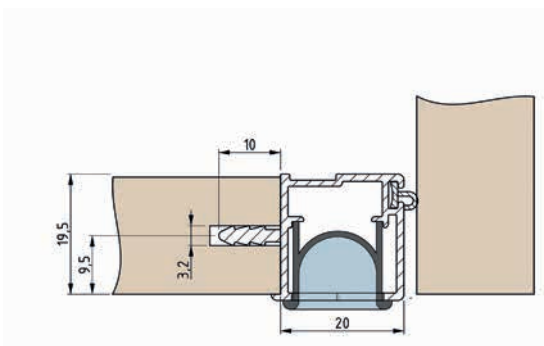



2168



2750 (1833) **Lk**

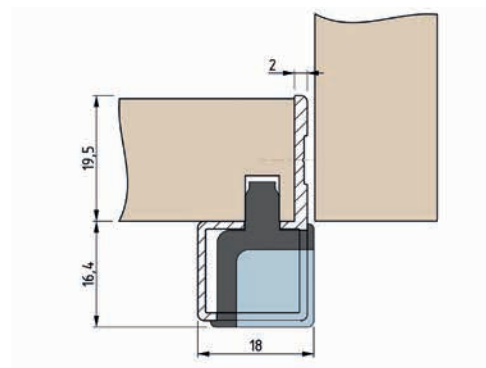

2169



2750 (1833) **Lk**

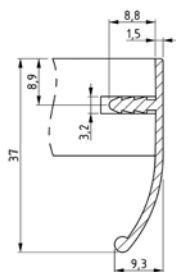

325.37



2750 (1833)

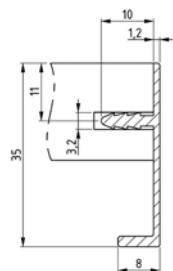

464.35



2750 (1833)

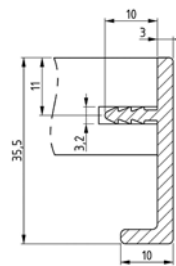

555.95



2750 (1833)

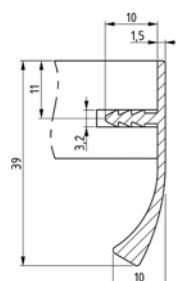

2192



2750 (1833)

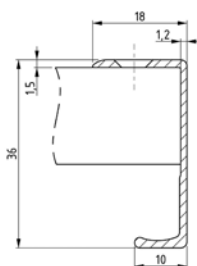

658.35



2750, 2300, (1833)

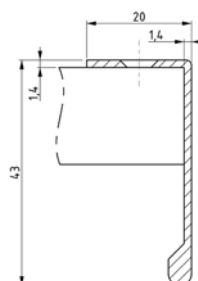

466.43



2750 (1833)

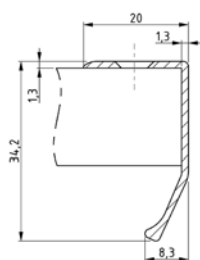

643.33



2750 (1833)

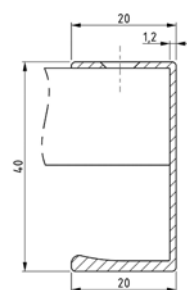

606.40



2750 (1833)

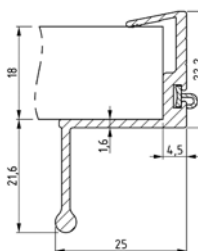

444.25



2750 (1833)

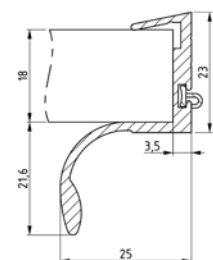

445.25



2750 (1833)

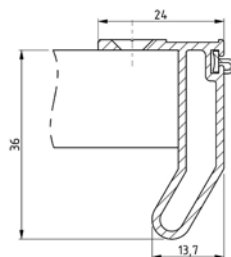

2107



2750 (1833)

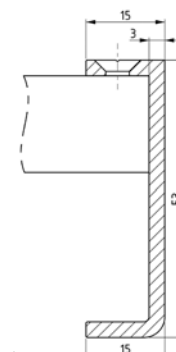

552.15



2750 (1833)





665.12

648.12

525.27

561.20

568.28

665.12



864



1090



33



12

648.12



864



1090



33



12

525.27



128 + 800



1100



27



7

561.20



960



1060



29



20

568.28



882



927



30



28





520.20C



574.10C



632.27BC





kolpa-san

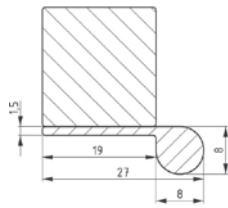

616.08

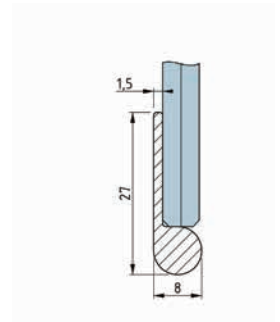

616.08B





2109A



	160	256	352	
	211	307	403	
	42+42			
	16			



2188



	40
	30



2144



	192
	208
	26+26
	16



2189



	256
	292
	45+45
	15



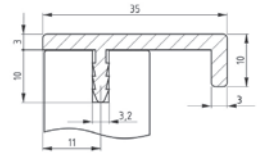

555.95



145	195	245	295	345	395	445	495	545	595	695	795	895	995	1095	1195	(Lx)
147	197	247	297	347	397	447	497	547	597	697	797	897	997	1097	1197	(Lx)

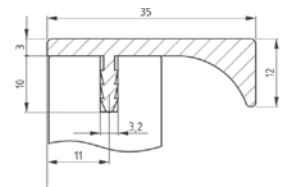

2217



146	196	246	296	346	396	446	496	546	596	696	796	896	996	1096	1196	(Lx)
-----	-----	-----	-----	-----	-----	-----	-----	-----	-----	-----	-----	-----	-----	------	------	------

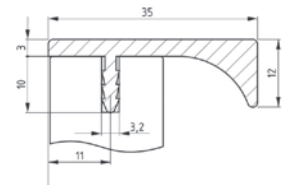

2141



147	197	247	297	347	397	447	497	547	597	697	797	897	997	1097	1197	(Lx)
-----	-----	-----	-----	-----	-----	-----	-----	-----	-----	-----	-----	-----	-----	------	------	------



2192



147 197 247 297 347 397 447 497 547 597 697 797 897 997 1097 1197

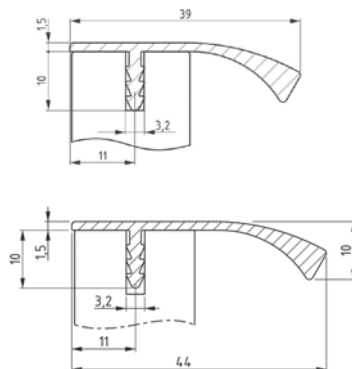

NOVO
NEW

2222



147 197 247 297 347 397 447 497 547 597 697 797 897 997 1097 1197

2192B



147 197 247 297 347 397 447 497 547 597 697 797 897 997 1097 1197

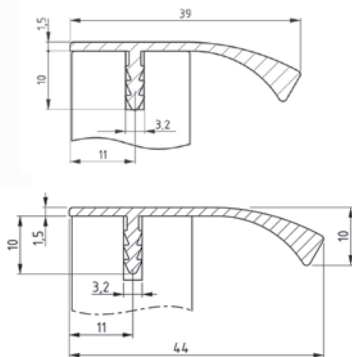

NOVO
NEW

2222B



147 197 247 297 347 397 447 497 547 597 697 797 897 997 1097 1197

2192C



147 197 247 297 347 397 447 497 547 597 697 797 897 997 1097 1197

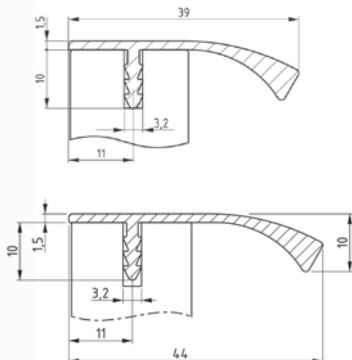

NOVO
NEW

2222C



147 197 247 297 347 397 447 497 547 597 697 797 897 997 1097 1197

2192D



147 | 197 | 247 | 297 | 347 | 397 | 447 | 497 | 547 | 597 | 697 | 797 | 897 | 997 | 1097 | 1197 |

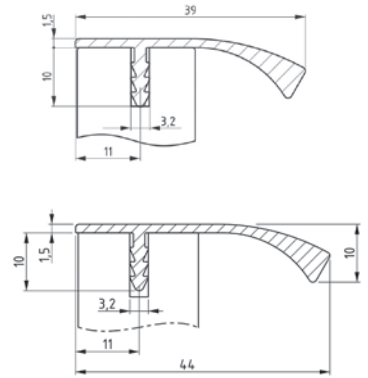

NOVO
NEW

2222D



147 | 197 | 247 | 297 | 347 | 397 | 447 | 497 | 547 | 597 | 697 | 797 | 897 | 997 | 1097 | 1197 |

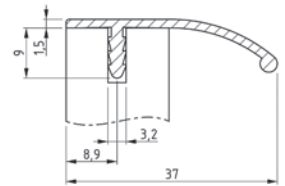

398.37



145 | 195 | 245 | 295 | 345 | 395 | 445 | 495 | 545 | 595 | 695 | 795 | 895 | 995 | 1095 | 1195 |

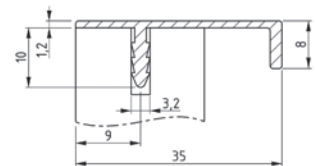

464.35

464.35



152 | 452 | 1052 | 1052 |

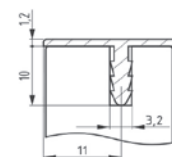

2118

2118



2750 |

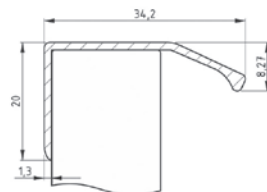

656.35 		147	197	247	297	347	397	447	497	597	697	797	897	997	1097	1197	<input type="checkbox"/> (LX)
		100	140	190	220	260	300	2x195	2x220	2x260	2x300	3x240	3x270	3x290	3x320	3x350	<input type="checkbox"/> (X)

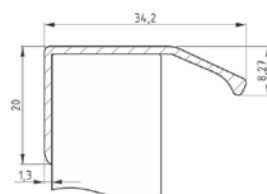

643.33 		45	90	160	200	<input type="checkbox"/> (LX)
		16	64	128	160	<input type="checkbox"/> (X)

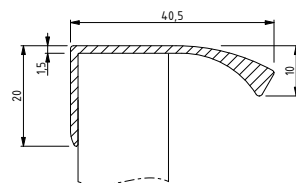
 NOVO
 NEW

12.002A 		147	197	247	297	347	397	447	497	547	597	697	797	897	997	1197	<input type="checkbox"/> (LX)
		64	128	192	192	224	288	320	2x192	2x224	2x256	2x288	3x224	3x256	3x288	3x352	<input type="checkbox"/> (X)

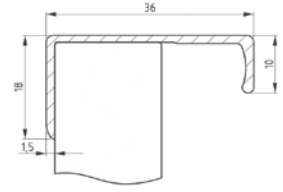

658.35



	50	90	200	(LX)
	32	64	160	(X)

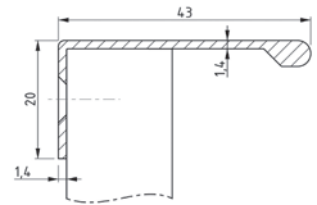

466.43



	40	200	2750	(LX)
	32	128	0	(X)

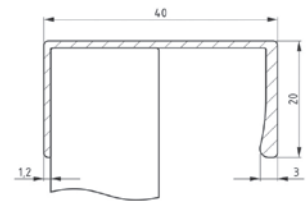

606.40



	50	200	305	500	(LX)
	32	160	288	2x224	(X)

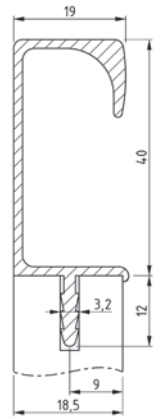

401.40



145 | 195 | 245 | 295 | 345 | 395 | 445 | 495 | 545 | 595 | 695 | 795 | 895 | 995 | 1095 | 1195 |

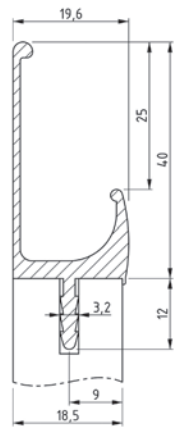

345.18



145 | 195 | 245 | 295 | 345 | 395 | 445 | 495 | 545 | 595 | 695 | 795 | 895 | 995 | 1095 | 1195 |

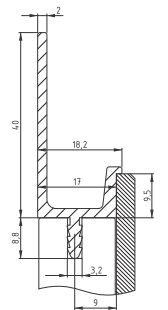

2139



146 | 196 | 246 | 296 | 346 | 396 | 446 | 496 | 546 | 596 | 696 | 796 | 896 | 996 | 1096 | 1196 |



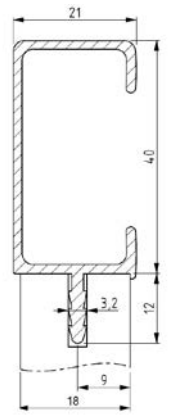

455.18



164 | 264 | 314 | 364 | 464 |

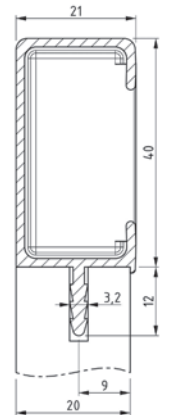

433.21



164 | 264 | 314 | 364 | 464 |

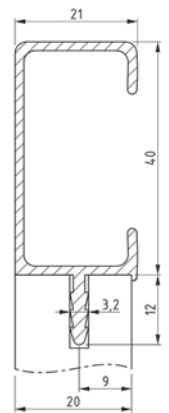

452.21



145 | 195 | 245 | 295 | 345 | 395 | 445 | 495 | 545 | 595 | 695 | 795 | 895 | 995 | 1095 | 1195 |



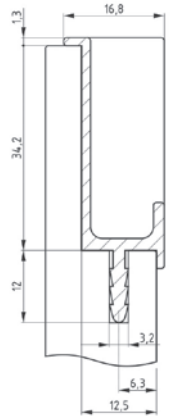

326.15

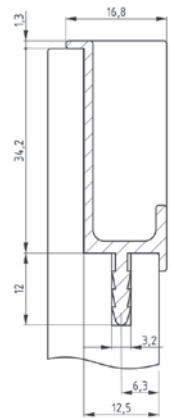
	108	140	172	204	236	
	96	128	160	192	224	

326.15B

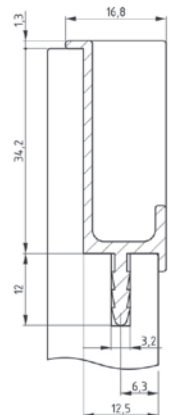
	145	195	245	295	345	395	445	495	545	595	695	795	895	995	1095	1195	
--	-----	-----	-----	-----	-----	-----	-----	-----	-----	-----	-----	-----	-----	-----	------	------	--

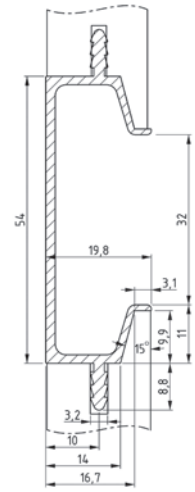
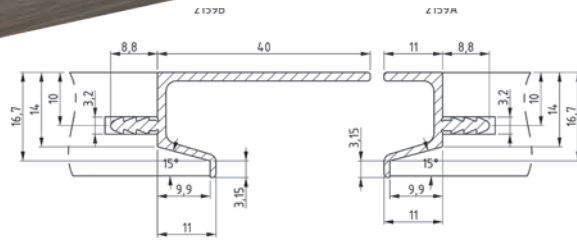
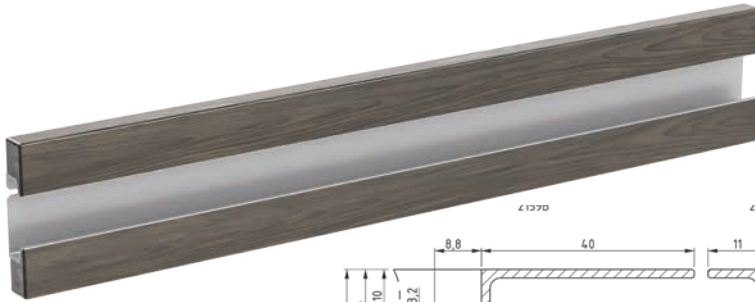
326.15L + (D)

2159B

2159A

2159C

2159A / B / C



145	195	245	295	345	395	445	495	545	595	695	795	895	995	1095	1195	(LX)
147	197	247	297	347	397	447	497	547	597	697	797	897	997	1097	1197	(LX)



NOVO
NEW

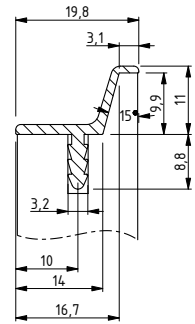

2159D



147	197	247	297	347	397	447	497	547	597	697	797	897	997	1197	(LX)
-----	-----	-----	-----	-----	-----	-----	-----	-----	-----	-----	-----	-----	-----	------	------

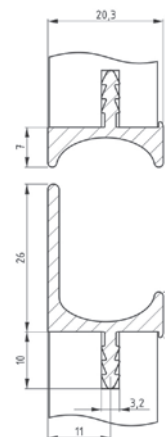

2198A

2198B

2198A / B



147	197	247	297	347	397	447	497	547	597	697	797	897	997	1097	1197	(LX)
-----	-----	-----	-----	-----	-----	-----	-----	-----	-----	-----	-----	-----	-----	------	------	------



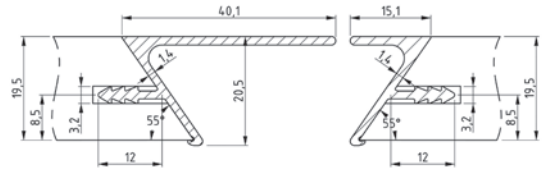

2197B

2197A

2197A / B



147

197

247

297

347

397

447

497

547

597

697

797

897

997

1097

1197

(LX)

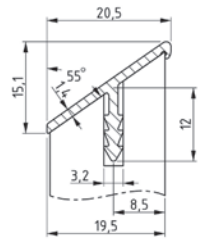

2197



147

197

247

297

347

397

447

497

547

597

697

797

897

997

1097

1197

(LX)

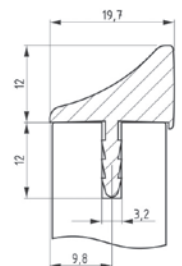

441.97



147

197

247

297

347

397

447

497

547

597

697

797

897

997

1097

1197

(LX)



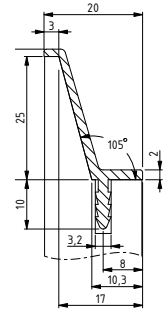

2142



146

196

246

296

346

396

446

496

546

596

696

796

896

996

1096

1196

(Lx)

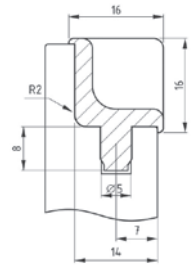

U11/14



2x128



298

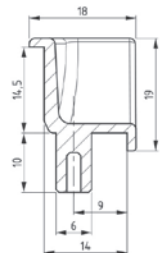

586.14



96

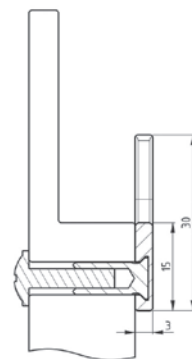

170

2171



360

(L)

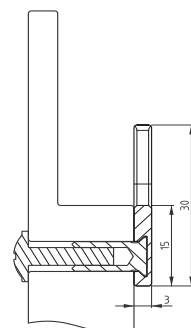

2x160

(K)

2171L (R)

300

(L)



2x128

(K)

L - Left, R - Right

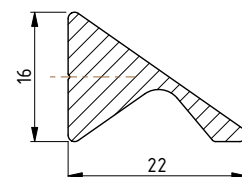
 NOVO
 NEW

690.16

64

96

128

160

192

224

256

288

320

352

(L)



140

190

240

290

340

390

440

490

540

590

(K)

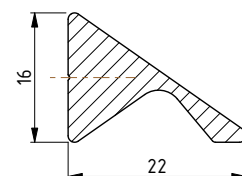
 NOVO
 NEW

690.16

64

96

128

160

192

224

256

288

320

352

(L)



140

190

240

290

340

390

440

490

540

590

(K)

NOVO
NEW

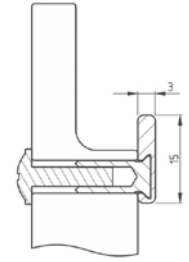

674.15

	197	247	297	347	397	447	497	597	697	797	897	997	1097	1197	
	120	2x85	2x110	2x135	2x160	2x185	2x210	4x130	4x155	4x180	4x205	4x230	4x255	4x280	

NOVO
NEW

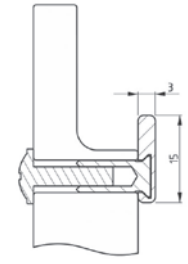

674.15B

	101	197	347	
	64	2x80	2x160	

NOVO
NEW

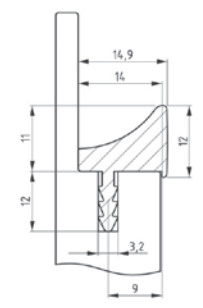

10.001

	147	197	247	297	347	397	447	497	547	597	697	797	897	997	1097	1197	
--	-----	-----	-----	-----	-----	-----	-----	-----	-----	-----	-----	-----	-----	-----	------	------	--

NOVO
NEW

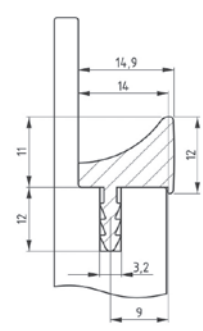

10.001B

	100	200	350	
--	-----	-----	-----	--

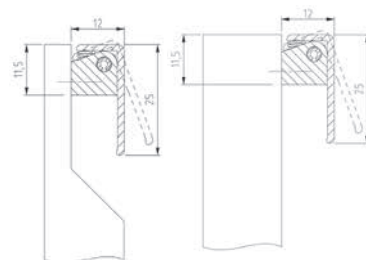
 NOVO
 NEW

675.25		60	147	197	247	297	347	397	447	<input type="checkbox"/> Lx
		32	32	106(170)	156(220)	206(270)	256(320)	306(370)	256(420)	<input type="checkbox"/> X
		497	547	597	697	797	897	997	1197	<input type="checkbox"/> Lx
		406(470)	456(520)	506(570)	606(670)	706(770)	806(870)	906(970)	1106(1170)	<input type="checkbox"/> X

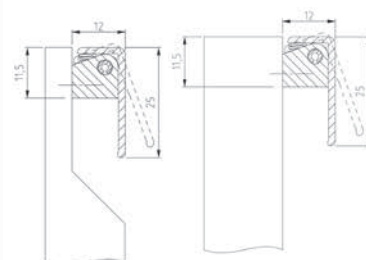
 NOVO
 NEW

675.25B		198	<input type="checkbox"/> Lx
		96+ (160)	<input type="checkbox"/> X

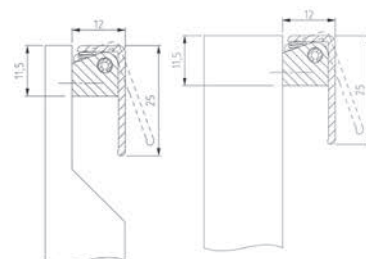
 NOVO
 NEW

675.25CL (R)		96+(160)	256+(320)	<input type="checkbox"/> Lx
		199	359	<input type="checkbox"/> X L - Left, R - Right

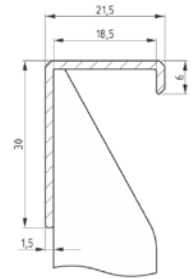

609.18		147	247	297	347	397	447	497	597	797	897	997	1097	1197	(LX)
		100	190	220	250	250	220/400	220/450	220/540	220/720	220/800	200/900	220/1000	220/1000	(X)

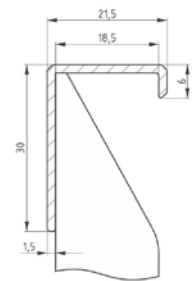

609.18D		170	270	470	(LX)
		150	250	450	(X)

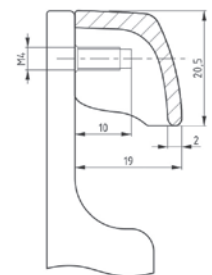

437.20		200	250
		160	224

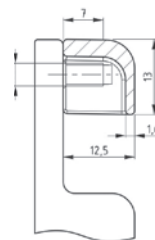

615.13



	125
	96

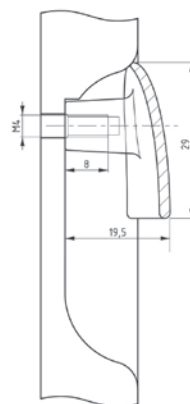

435.30



	162
	128

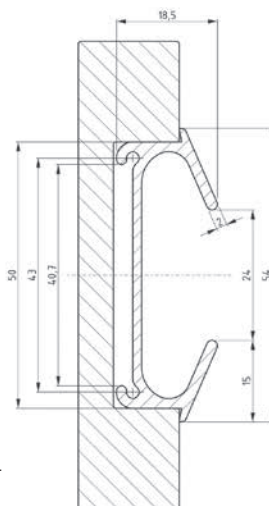

403.07



	147	179	211	243	275			54
	128	160	192	224	256			12
	49x137	49x169	49x201	49x233	49x265		49x	7



U12AC



U12AE

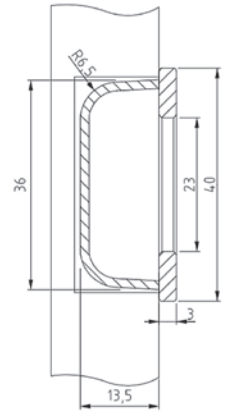

U12AC



	108	172
	96	160
	36x103,5	36x103,5

U12AE



	130	180	255
	96	96+(64)	96+(128)
	36x103,5	36x103,5	36x103,5



U12BC



U12BE

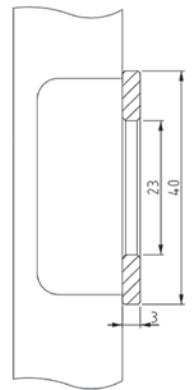

U12BC



	108	172
	96	160

U12BE



	130	180	255
	96	96+64	96+128



NOVO
NEW

U11.001/35



	41.7
	f35
	13.5
	2

U11.001/50



	54.7
	f50
	13.5
	2

U6.137/45

128



50



138x46



14



142



2

U6.56/45

32



50



57x46



14



61



2

U7.180/40

160



50



40x180



15



192



5

U9.175/55

160



55



46x168



13,5



175



2

U9.41/41

28



41



f35



13,5



41



2





NOVO
NEW

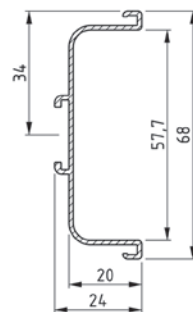
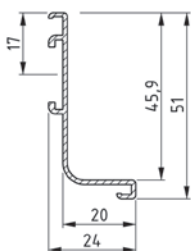
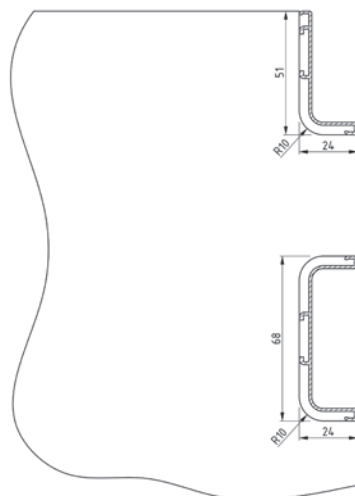

2199L



5500

3500

2750



2199C



5500

3500

2750



2199C.F

2199L.F

2199C.E

2199L.E

2199L.I

2199L.O

2199C.IS

2199C.OS

2199L.IS

2199L.OS

MONTAŽNI SISTEMI
FITTING SYSTEM

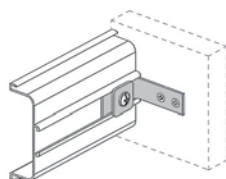

2199K

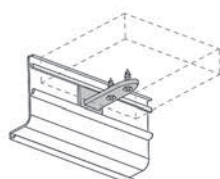

2199T-18 / T-19

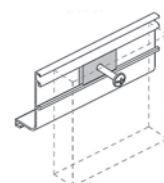

2199P

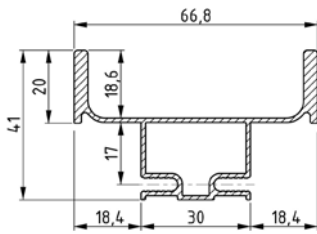
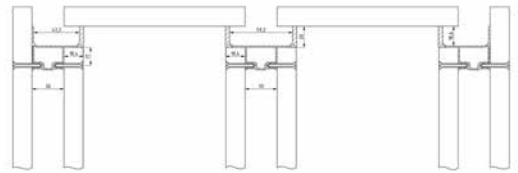
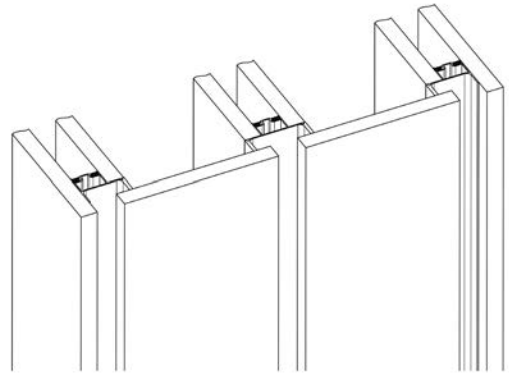

NOVO
NEW

2200C



4500

2400

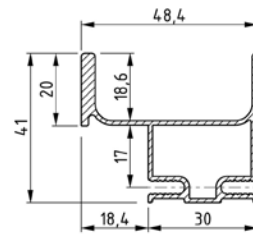

NOVO
NEW

2200L



4500

2400

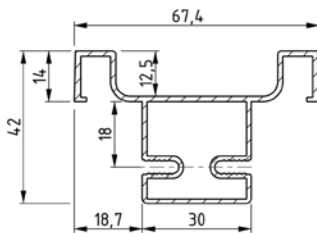

2146



4500

2250

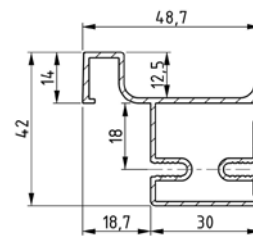

2147



4500

2250





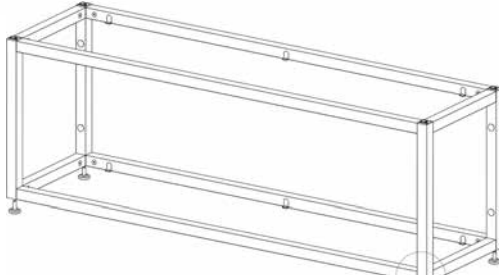
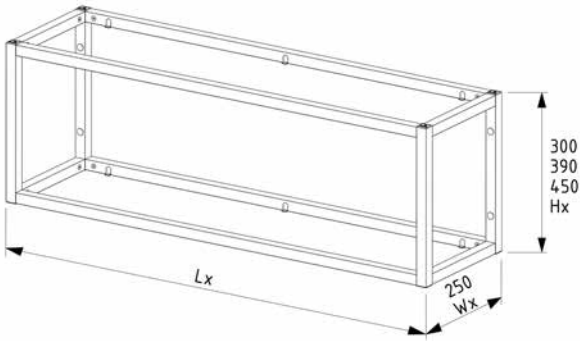

Nivelator +10/-0mm
Leveler +10/-0mm

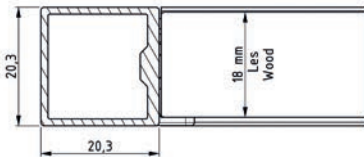
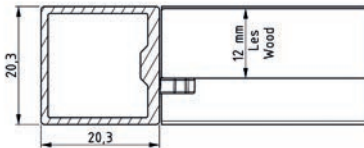
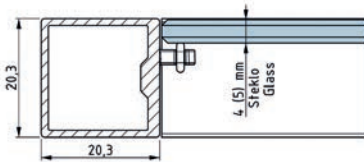

60.001/1x1

CUBUS 1/1



60.001/2x1

CUBUS 2/1



60.001/1x2

CUBUS 1/2



60.001/1x2

CUBUS 2/2

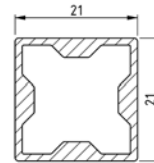

VERTIKALNI PROFIL
VERTICAL PROFILE

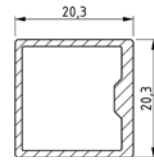

HORIZONTALNI PROFIL
HORIZONTAL PROFILE

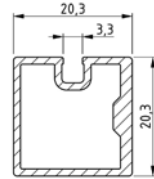

PROFIL ZA DRSNNA VRATA
SLIDING DOOR PROFILE

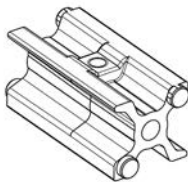

VEZNI ELEMENTI
CONNECTING PIECE



NIVELATOR
LEVELER



PLASTIČNI POKROV
PLASTIC COVER



NOSILEC LESENE POLICE 18 (19) MM
HOLDER FOR WOODEN SHELF 18 (19) MM



NOSILEC STEKLENE POLICE 4 (5) MM
HOLDER FOR GLASS SHELF 4 (5) MM

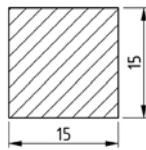

NOSILEC LESENE POLICE 12 MM
HOLDER FOR WOODEN SHELF 12 MM

NOVO
NEW

30.001

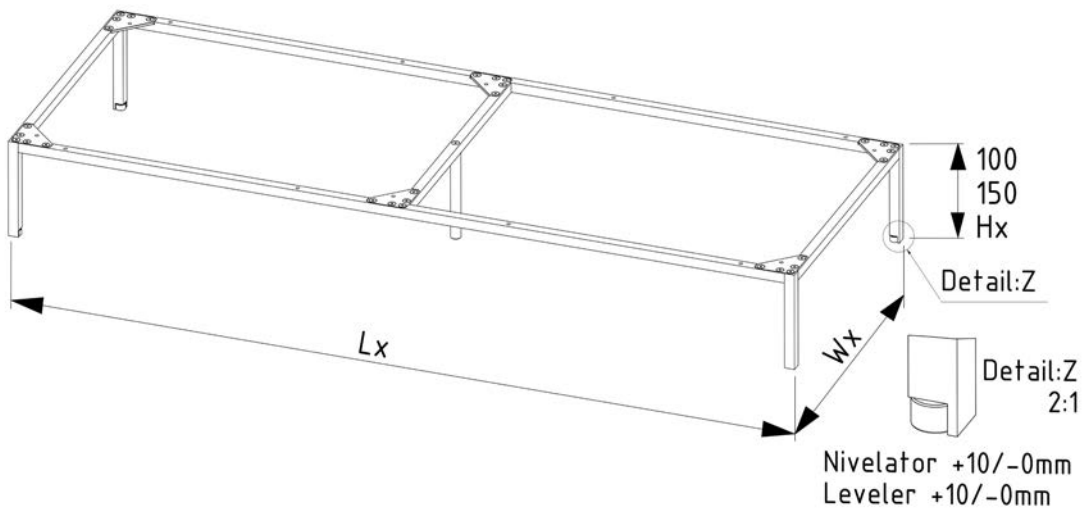



NOVO
NEW

80.001



300	350	400	450	500	600	700	(LX)
-----	-----	-----	-----	-----	-----	-----	------

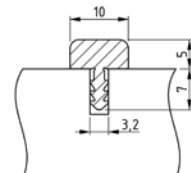

80.002



300	350	400	450	500	600	700	(LX)
-----	-----	-----	-----	-----	-----	-----	------



200	250	300	350	400	2x224	2x256	(X)
-----	-----	-----	-----	-----	-------	-------	-----

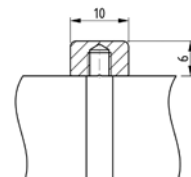

80.003



300	350	400	450	500	600	700	(LX)
-----	-----	-----	-----	-----	-----	-----	------

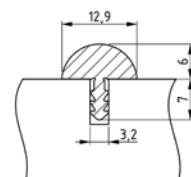



KOVINSKI ROČAJI IN GUMBI



METAL HANDLES AND KNOBS

**590.01**

	1
	29
	23
	28

**590.02**

	16
	49
	23
	40

**590.03**

	32
	122
	23
	37

**501.10**

	32
	80
	80
	10

**500.10**

	96
	175
	50
	10

**502.10**

	16
	50
	50
	10

**528.03**

	224	320		28
	233	329		40



557.02



32



50



50



20



557.04



128



50



175



20



557.01



16



80



30



24



557.03



64



80



80



24



437.20



160

224



19



200

250



20

MADE WITH
SWAROVSKI
ELEMENTS**580.26sw**

	160	224		26
	172	236		14

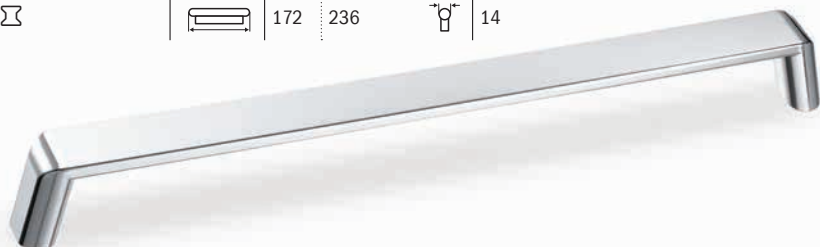
**580.26**

	160	224		26
	172	236		14

**836.26**

	18
	26
	14

NOVO
NEW**692.18**

	160	320		26
	177	337		18

**588.25**

	160	224		25
	172	236		21



587.25		160	224		25
		170	234		15



604.27		160	224		27
		175	239		26

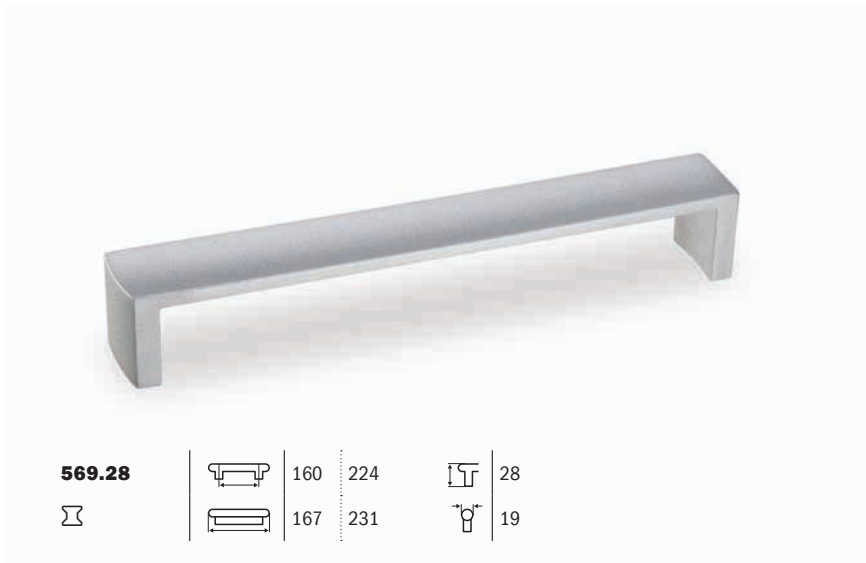

569.28		160	224		28
		167	231		19



832.28		28
		19

**667.20**

1

128



29



28

198



28(20)

**668.15**

160

224



29



218

282

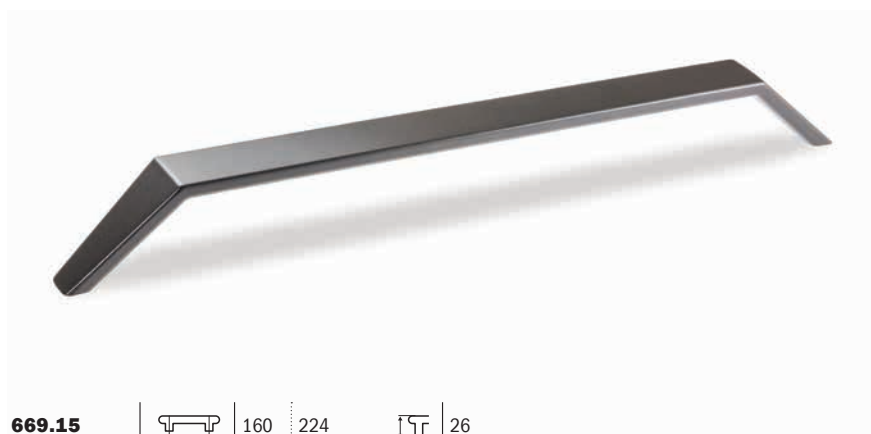

15

**669.15**

160

224



26



168

232



15



354.25		96	128	192		28	24	28
		115	156	226		25	20	25



685.10		128	160	224	256	320		30
		138	170	234	266	330		10



NOVO
NEW

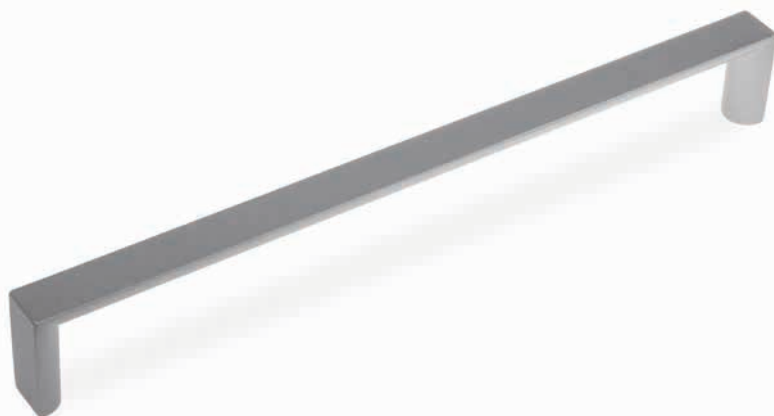

677.08		160		28
		168		8

**415.26R**

96

128

192



27



102

134

198



12

**495.25**

160



29



167



25

**529.27**

96

128

160

192

256



27



113

150

190

222

286



9



516.30		128	192		24
		170	234		

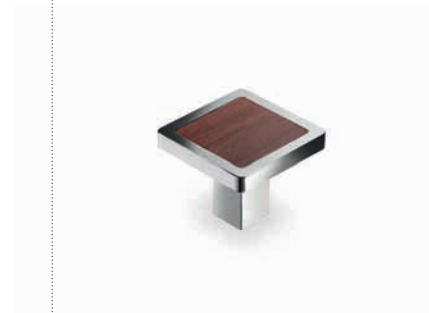

826.30		1
		30
		24
		30



516.30B		128	192		25
		170	234		



826.30B		1
		30
		25
		30



516.30E		128	192		24
		170	234		



826.30E		1
		30
		24
		30



90

KOVINSKI ROČAJI IN GUMBI
METAL HANDLES AND KNOBS

446.24R		128	160	224		25
		159	193	267		15



447.20R		96	128	160		24	25	26
		135	179	211		20	22	24



497.22		160		28
		191		22



360.28		160		28
		190		15



367.20		16
		30
		21
		27



496.14		160		29
		169		14



603.29		160		29
		168		11





361.25		96	128	160		21	24	25
		131	165	205		20	25	30



362.21		16
		30
		21
		30



462.25		96	128	160		21	24	25
		130	165	205		20	25	30



362.21A		16
		30
		21
		30



396.25		96	128	160		21	24	25
		130	165	205		20	25	30



362.21D		16
		30
		21
		30



498.16		128	192		26
		144	208		16



536.16		128	192		26
		144	208		16



527.13		64	128		15
		80	176		13



527.13B		64	128		15
		80	176		13

NOVO
NEW



691.26		192		26
		228		26



370.30		160		25
		240		30



387.20		160		26
		275		20



386.20		160		25
		180		20



311.20		25
		45
		20
		20



219.08		96		24
		113		8



219.10		128	192		30	31
		150	229		10	10



304.16		96	128		26	30
		113	148		17	22



583.19		96+(128)	128+(160)		22	25
		136	168		19	19

**160.12**| ϕ | 12

| | 21

**807.24**| ϕ | 24

| | 21

**199.15**

| | 15

| | 23

**199.15D**

| | 15

| | 25

**805.13**| ϕ | 13

| | 30

**836.26**

| | 14

| | 26

**194.20**| ϕ | 20

| | 18

**823.18**| ϕ | 18

| | 26

**510.34**

| | 64

| | 75

| | 34

| | 19

**454.20**

| | 64

| | 74

| | 20

| | 10

**584.19**

| | 96

| | 120

| | 19

| | 23



834.11



	11
	11
	26



832.28



	19
	19
	28



803.25



	25
	25
	20



825.32



	16
	47
	18



652.20



	16
	20
	55



653.15



	16
	15
	25



833.20



	20
	28



850.40



	40
	30



613.27B



	16
	30
	27
	7



567.19



	23
	19



328.20B



	22
	20

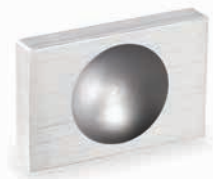

564.27



	32
	40
	27
	8

**667.20**

29



28

**851.30**

30



26

**163.26**

26



28

**809.24**

24



28

**367.20**

16



30



21



27

**311.20**

25



45



20



20

**819.32**

32



17



27

**804.15**

24



12



19

**362.21C**

16



30



21



30

**362.21B**

16



30



21



30

**826.30D**

30



24

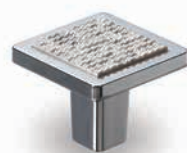

30

**826.30B**

30





25



30





170.18 | ϕ 26
 |  13





161.19 | ϕ 19
 |  15



162.24 | ϕ 24
 |  20





MS 7.25 | ϕ 25
 |  20



MS 5.20 | ϕ 20
 |  23



MS 5.25 | ϕ 25
 |  29



MS 3.28 | ϕ 28
 |  21



MS 4.28 | ϕ 28
 |  21



MS 6.38 | ϕ 38
 |  32



MS 6.32 | ϕ 32
 |  27



MS 6.25 | ϕ 25
 |  24



100

KOVINSKI ROČAJI IN GUMBI
METAL HANDLES AND KNOBS

Vintage





630.15		160	320	512		38
		175	335	572		15



636.15		160		22
		182		15



657.16		1	160		39
		35	210		16



**650.12**

1

160



33



35

210



12

**667.20**

1

128



29



28

198



28(20)

**347.20**

160

224



30



170

234



20



354.25		96	128	192		28	24	28
		115	156	226			25	20



516.30C		128		24
		170		



826.30C		1
		30
		24
		30



590.01		1
		29
		23
		28



590.02		16
		49
		23
		40



590.03		32
		122
		22
		37

**651.24**

32

96

160



20



110

180

250



24

**668.15**

160

224



29



218

282



15

**619.10**

160

270

370



36



197

307

407



10



387.20



160



26



275



20



386.20



160



25



180



20



583.19



96(128)

128(160)



22

25



136

168



19

19

**561.20**

1

64

110

160

210

260

360

560

660

760

960

29



100

164

210

260

310

360

460

660

760

860

1060

20

**415.26R**

96

128

192

27



102

134

198

12

**529.27**

96

128

160

192

256

27



113

150

190

222

286

9



613.27B		16	128	160	224	320		27
		32	160	224	320	416		

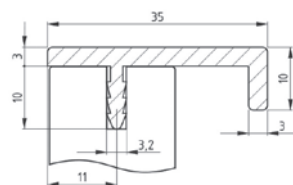

555.95		145	195	245	295	345	395	445	495	545	595	695	795	895	995	1095	1195
		147	197	247	297	347	397	447	497	547	597	697	797	897	997	1097	1197



U9.41/41		28		41	U9.175/55		160		55		
		f35				13,5			46x168		13,5
		41				2			175		2

**454.20**

	96
	74
	20
	10

**199.15D**

	1
	15
	25
	15

**851.30**

	1
	26
	30

**589.01**

	1		23
	43		26

**589.02**

	128		25
	140		30

**448.51R**

	76		51
	95		17

**449.95**

	56		95
	95		15



2202C



 140

 39



2187C



 100

 39



2202A



 140

 39



2187A



 100

 30

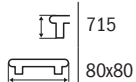
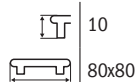
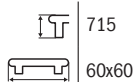
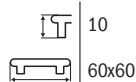
**2084****2130****2116.2****2116.1****2203.2****2203.1**

more information in the chapter "furniture legs"
več informacij v poglavju "pohištvene noge"









631.22B



	192	288	416		29
	215	340	465		22



667.20



	1	128		29
	28	198		28(20)



650.12



	1	160		33
	35	210		12



589.02		128		25
		140		



589.01		1
		43
		23
		26



516.30C		128		24
		170		

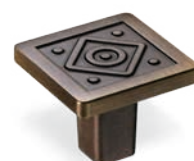

826.30C		1
		30
		24
		30



516.30B		128	192		25
		170	234		



826.30B		1
		30
		25
		30



236.16



128



160



26



16



128.18



28



18



NOVO
NEW

681.15



128



144



26



15



386.20



160



180



25



20



311.20



25



45



20



20

**416.14**

64



48



95



14

**815.14**

1



32



50



14

**298.12**

96



65



120



14

**220.10+P4**

64



105



25



15

**851.30**

Φ 30



26

**MS 3.28**

Φ 28



22

**MS 7.25**

Φ 25



20



162.24 | ϕ 24
 |  20





199.15D |  15
 |  25





170.18 | ϕ 26
 |  13



114.30 | ϕ 30
 |  26





114.30+P3 |  70
 |  30







118.30 | ϕ 30
 |  28

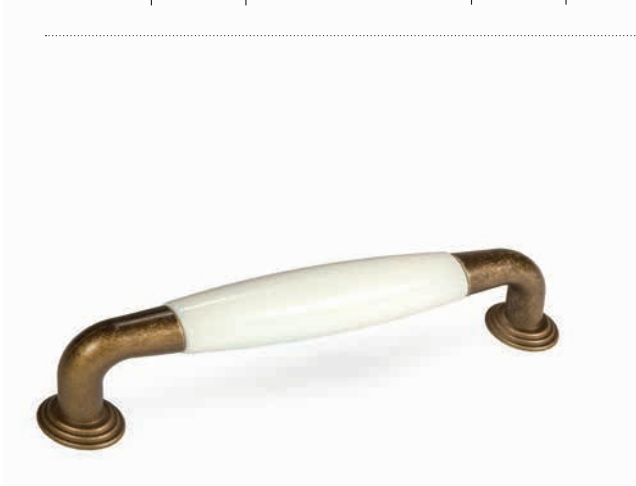





171.32 | ϕ 32
 |  26

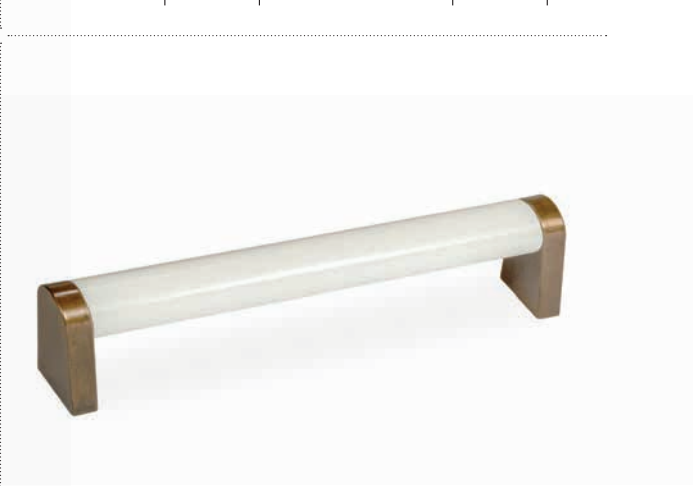

259.18 |  128 |  34
 |  148 |  20



285.13 |  128 |  31
 |  135 |  17

**636.15**

160



22



182



15

**269.22**

128



30



162



23

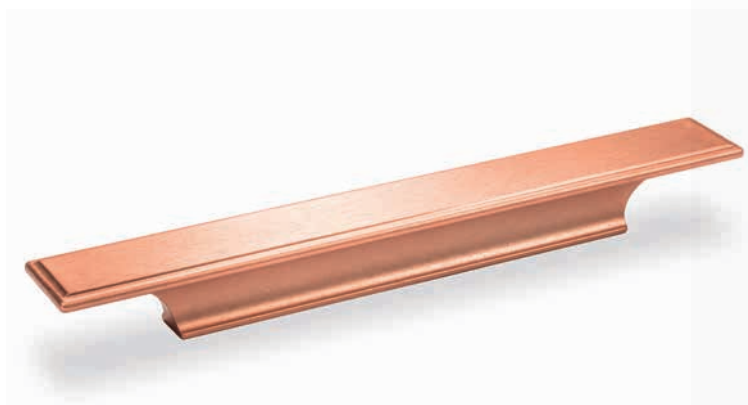

651.24



	32	96	160	(X)
	110	180	250	(X)



20



24



851.30



Φ 30

28



587.25



	160	224		25
	170	234		15

The image is a close-up, artistic photograph. It features a wooden handle, likely made of a light-colored wood, extending from the bottom left towards the center. At the end of the handle is a metal knob or handle, which is out of focus. The background is a solid, warm orange color. In the upper right corner, there is a diagonal wooden beam with a light blue strip attached to it. The overall composition is minimalist and focuses on the textures and colors of the materials.

ROČAJI IN GUMBI IZ LESA



WOODEN HANDLES AND KNOBS

**414.14**

96



34



350



14

NOVO
NEW**613.27B**

16

128

160

224

320



27



32

160

224

320

416



8

**347.20**

160

224



30



170

237



20



289.26 ♻️		160	224	320		30
		170	234	330		



166.10 ♻️		26
		30
		10



528.01 ♻️		224	320		28
		233	329		



539.01A ♻️		16
		40
		24
		40



539.02A ♻️		96
		162
		24
		40



539.03A ♻️		96
		216
		24
		40

**556.10**

128

160

224

320

416



32



166

198

262

358

454



10

**830.10**

30



32



10

**382.42**

320



42



330

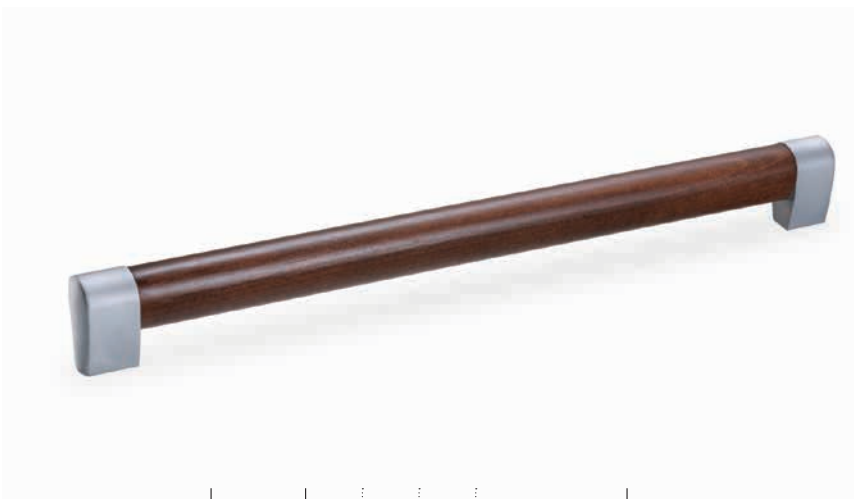

14

**493.35**

96

128

288

320



35



115

147







307

339









15









350.43		160	224	288		31
 		168	232	296		43



258.28		160		30
 		179		27



308.22		160		26
 		194		22



476.15		170	270	320	370		38
		182	282	332	382		15



541.15		160	224		30
		170	243		15



237.13		160	192
		210	242
		30	
		13	

285.13		96	128	192
		103	135	199
		31		
		17		

259.18		128	160
		148	180
		34	
		20	



204.16		96		31
		112		16

213.14		96		23
		126		14

221.10		96		24
		133		10



U1.150

	50		11
	55		6



U3.150

	50		11
	68		5



U2.150

	50
	55
	11
	5



U2.140

	40
	45
	11
	5



U2.135

	35
	40
	11
	5



114.30

ϕ	30
	26



114.30+P3

	70
	28
	30



118.30

ϕ	30
	26

**810.18**

Φ 18

|
IUF 27**132.25D**

Φ 25

|
IUF 31**149.35**

Φ 35

|
IUF 27**811.34**

Φ 34

|
IUF 32**124.27**

Φ 30

|
IUF 34**135.30**

Φ 30

|
IUF 41**144.32**

Φ 32

|
IUF 30**145.28**

Φ 28

|
IUF 35**171.32**

Φ 32

|
IUF 26**L1.03.32**

Φ 32

|
IUF 28**L1.04.35**

Φ 35

|
IUF 37**L1.05.36**

Φ 35

|
IUF 34





PLASTIČNI ROČAJI
USNJEI ROČAJI



PLASTIC HANDLES
LEATHER HANDLES



154.40	Φ	40
Σ	⊏	25



816.70	Φ	68
Σ	⊏	27



842.30	Φ	48
Σ	⊏	30



847.24	Φ	55
Σ	⊏	24



155.40	Φ	40
Σ	⊏	28



277.32	⊏	32	⊏	15
Σ	⊏	50	⊏	27



472.52	⊏	32	⊏	23
Σ	⊏	55	⊏	50



469.50	⊏	32	⊏	23
Σ	⊏	60	⊏	49



470.50	⊏	32	⊏	23
Σ	⊏	55	⊏	49



471.55	⊏	32	⊏	23
Σ	⊏	41	⊏	55





506.32	⊏	32	⊏	30
Σ	Φ	62	⊏	26



601.26	⊏	32	⊏	26
Σ	⊏	97	⊏	85





843.22 ☼		45
		22
		41





844.24 ☼		70
		24
		52



845.27 ☼		1
		27
		52



846.25 ☼		53
		25
		56



169.30 ☼ Σ	ϕ	30
		32



117.30 ☼	ϕ	28
		30



106.14 ☼	ϕ	15
		25



104.14 ☼	ϕ	15
		18



109.20 ☼	ϕ	20
		24



132.25D ☼ Σ	ϕ	25
		31







124.27 ☼ Σ	ϕ	30
		32







172.32 ☼	ϕ	32
		28

172.39 ☼	ϕ	39
		29







600.01		64		87
		50		
				







600.02		64		87
		50		
				







600.03		64		87
		50		
				







600.04		64		87
		50		
				







600.05		64		87
		50		
				







600.06		87		87
		23		
				







600.07		64		87
		50		
				







600.08		64		87
		50		
				



600.09		64		87
		50		
				



600.00		64		87
		50		
				



828.40		40
		30
		40

829.100		24		36
		100		100



596.22		64		22
		110		110

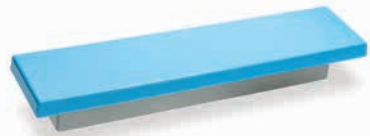

597.22		64		22
		130		34



598.32		128		32
		144		20



599.30		160		30
		205		60



530.24		160		26
		171		12



302.20		96	128	160	224
		108	140	175	238
		27	27	30	34
		17	20	20	20

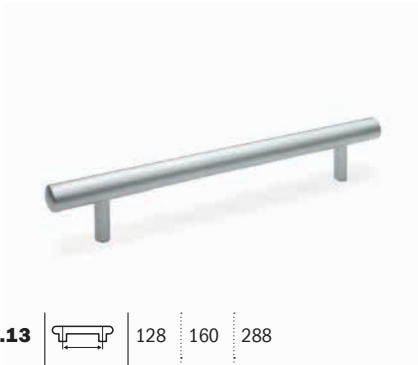

		128	160	288
		188	220	348
		32		
		12		



		128
		171
		27
		11



		128		31
		135		17



		50		12
		55		5



		160		33
		198		16



		35
		24
		16



	ϕ	30
		28



	ϕ	30
		26



	ϕ	32
		25



241.08		64		28
		96		



299.08		96		25
		116		



2153		73
		70
		3



2154		70
		70
		4



2155		64
		69
		3



2156		73
		50
		4



2157		137
		73
		3

**591.15**

16

160



22



30

200



32

**592.15**

160



25



169



30

**516.30F**

128

192



29



185

249



45

826.30F

47



27



322.16



160

320



36



230

390



16



577.19



160

544



40



215

630



19



NOVO
NEW

855.25



25



69



157.16



20







42







H O O K S





2123   
 | 119 | 75 | 47







2124   
 | 115 | 70 | 47







2130   
 | 100 | 50 | 50

2131   
 | 11 | 11 | 26







2084   
 | 103 | 7 | 58







2187A |  |  | 
 | 100 | 30 | 33







2202A |  |  | 
 | 140 | 39 | 41







2187C |  |  | 
 | 100 | 39 | 33



2202C |  |  | 
 | 140 | 39 | 41





2046 |  |  | 
 | 47 | 163 | 41



2045 |  |  | 
 | 39 | 89 | 32



2033 |  |  | 
 | 80 | 80 | 33



2120 |  |  | 
 | 60 | 41 | 43



2018



186	45	60



2053



55	64	31



2037



29	13	26



2100



16	47	32	18



652.20



16	55	20	17



2127



20	20	28

**2088**

130	49	35

**2121**

130	30	35

**2014**





123	60	40



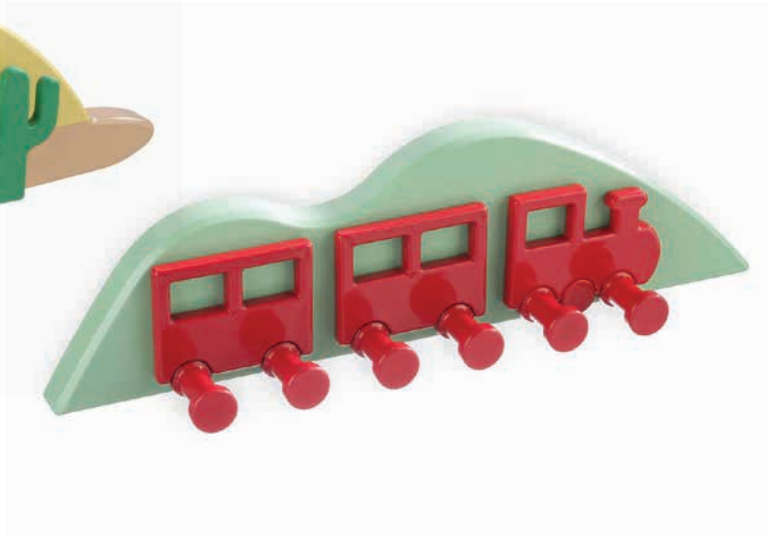
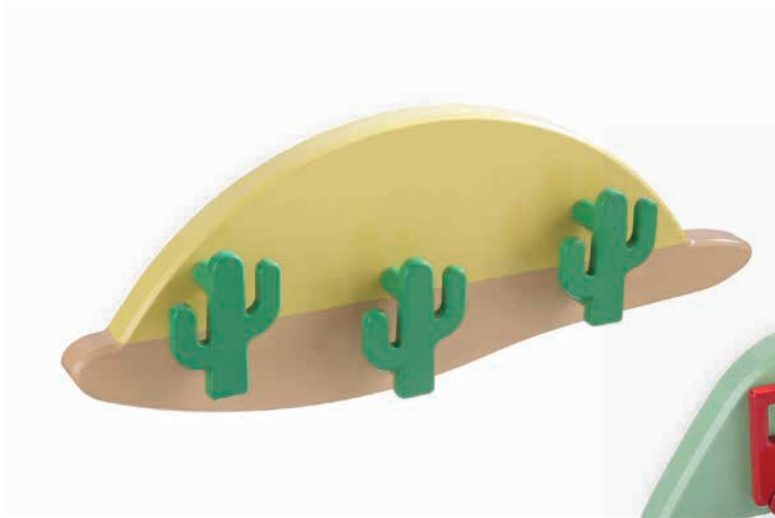

**2028**

116	87	51









2081 |  |  | 
  | 110 | 294 | 38

2082 |  |  | 
  | 86 | 280 | 38



2010 |  |  | 
  | 300 | 300 | 44

169.30 |  |  | 
 | 32 | 30 | 30

2087 |  |  | 
 | 45 | 90 | 90 | 18



2013 | | |
 | 100 | 67 | 51

2030 | | |
 | 147 | 25 | 60



2015 | | | |
 | 128 | 46 | 172 | 40







2001 | | |
 | 150 | 55 | 53

2004 | | |
 | 215 | 107 | 66







2043 |  |  | 
 | 55 | 318 | 43



40.003 |  |  | 
 | 76 | 80 | 46

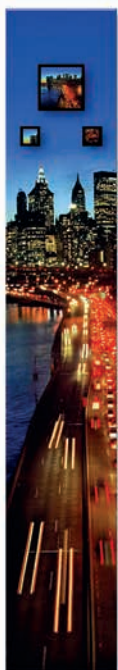

40.004 |  |  | 
 | 100 | 61 | 47

**TA 2090-92 SET****2x TA 2090-92 + 2x 2090-92**

250x1500x50

**2090**

100

100

36

**2092**

40

40

30

**2090 1x / 2092 2x**

227x160x40



A close-up, artistic photograph of a hand holding a pencil and a pen nib. The hand is positioned at the top left, with the pencil held between the fingers. The pen nib is visible on the right side, pointing towards the center. The background is a solid, warm yellow color. The lighting is soft, creating a gentle glow around the objects.

NOGE

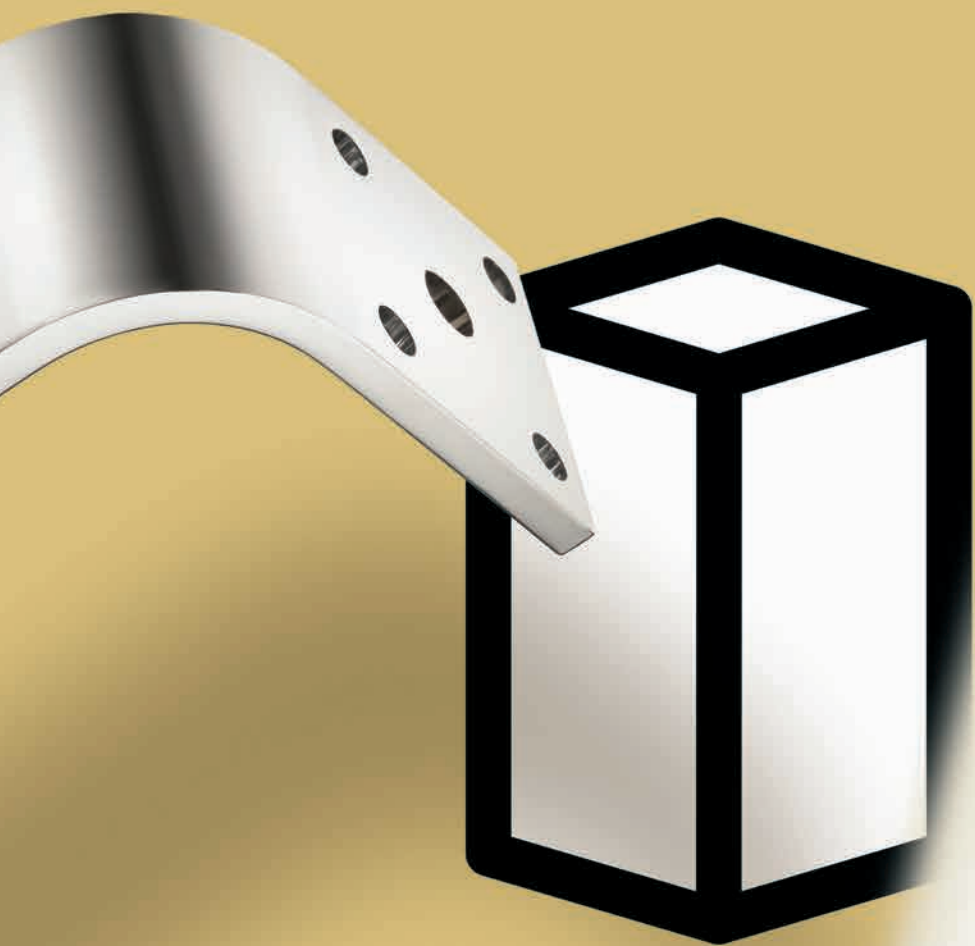

LEGS



**2178R**

100

150

200

+10

50x6

**2184B**

100

150

200

+10

20x20

**2150**

100

150

180

+5

37x37

**2158**

50

75

100

+10/-5

40x40

**2064**

65

75

125

+10

33x33

**2067**

105

+10

25x25

**2073**

110

0

70x70

**2066**

110

+10

Φ 35

**2070**

100

0

Φ 40



2072		230
		0
		100



2151		180
		0
		70



2062		70	130
		+10	+10
		50	50



2059		20	40	60
		0		
		75x75		



2057		30	40
		+15	
		100x100	



2017		30	40
		+15	
		100x100	



2152		110
		60x60



3002		22
		0
		52x52



156

NOGE
LEGS



MS 2116.1
MS 2203.1



NG 2116.2A
NG 2203.2A



DR 2116.3
DR 2203.3

RE 2116.4
RE 2203.4

SPOJ

DESK TOP+DESK LEG



PS 2116.5/80
PS 2116.5/100
PS 2203.5/60
PS 2203.5/80

MS 2116.1
MS 2203.1

NG 2116.2L/80
NG 2116.2L/100
NG 2203.2L/60
NG 2203.2L/80

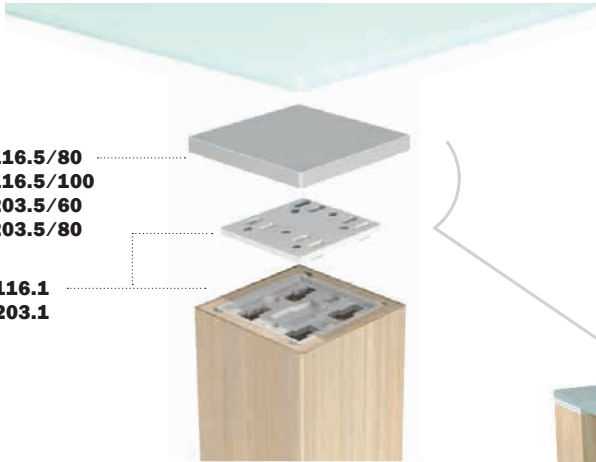



alu okrasni element decorative plate	PS 2116.5/80		86x86	10
alu okrasni element decorative plate	PS 2116.5/100		100x100	10
spojni mehanizem joint	MS 2116.1		80x80	10
alu noga alu leg	NG 2116.2A		80x80	715,
lesena noga wooden leg	NG 2116.2L/80		80x80	720
lesena noga wooden leg	NG 2116.2L/100		100x100	730
drsni slider	DR 2116.3		80x80	5
regulator leveler	RE 2116.4		fi 40	+ -5



60 x 60 / MS 2203.1



80 x 80 / MS 2116.1

rd PATENTIRAN MEHANIZEM
PATENTED MECHANISM

alu okrasni element decorative plate	PS 2203.5/60		65x65	10
alu okrasni element decorative plate	PS 2203.5/80		80x80	10
spojni mehanizem joint	MS 2203.1		60x60	8
alu noga alu leg	NG 2203.2A		60x60	715,
lesena noga wooden leg	NG 2203.2L/60		60x60	718
lesena noga wooden leg	NG 2203.2L/80		80x80	720
drsni slider	DR 2203.3		60x60	3
regulator leveler	RE 2203.4		fi 28	+ -5



80x80
alu noge / alu legs

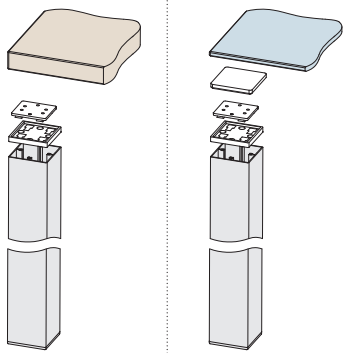

80x80
lesene noge / wooden legs

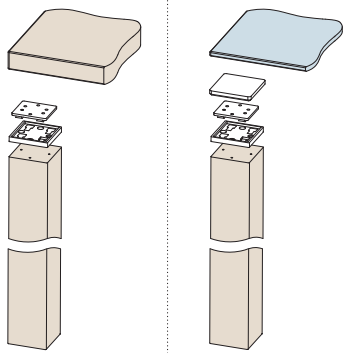

100x100
lesene noge / wooden legs

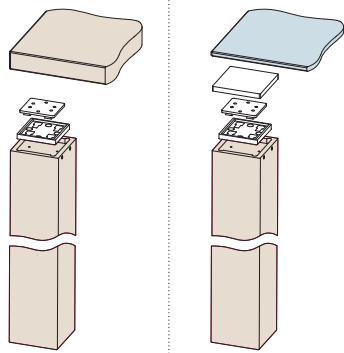

60x60
alu noge / alu legs



60x60
lesene noge / wooden legs



80x80
lesene noge / wooden legs





POSEBNI PROJEKTI

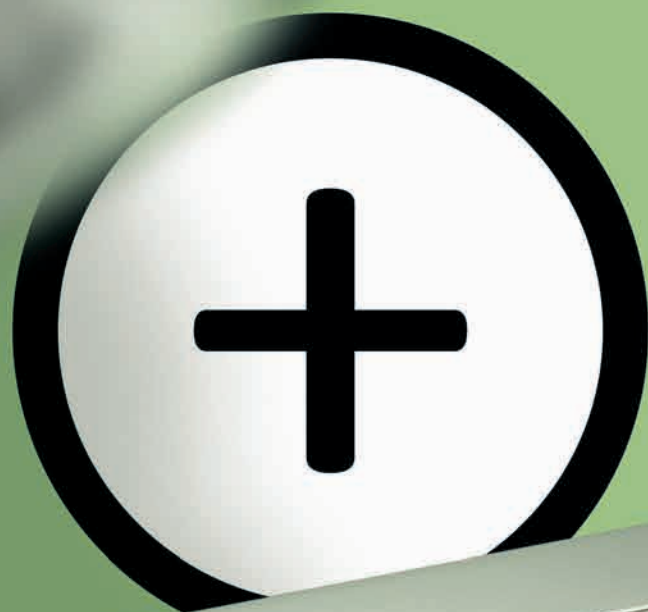

SPECIAL PROJECTS





2016	IS	S	h+
Σ	800	126	75

PREZENTACIJE PRESENTATIONS



PRODAJNO RAZSTAVNA PREZENTACIJA

Prezentacijski prodajno-razstavní panel je namenjen prezentaciji programa na fleksibilen naèin, saj omogoèa hitro menjavo vzorcev in nadomeščanje le teh z novimi, aktualnejšimi modeli. Dimenzije panela so 450 x 2200 mm, lahko pa jih razširimo v 2, 3 ali več delne prezentacije, glede na zanimanje in razpoložljivost prostora. Prezentacija je lahko stenska, lahko je prostostojeèa na podstavku, enostranska ali dvostranska. Izbor modelov je fleksibilen in prepušèen dogovoru.

DISPLAY PANEL

The display panel is specifically designed to allow easy and quick changes to your handles presentation. Each one measures 2200 mm in height and 450 mm in width. Multiple panels can be joined together as per your wishes and available space. It can be mounted on a wall or self-standing on a base, which also enables two-sided presentations. The product selection to be presented on these panels is according to an agreement.



PREZENTACIJA PROGRAMA GOLA

Prezentacijski panel programa Gola je oblikovan tako, da so predstavljeni vsi sestavni deli tega projekta, vse oblike alu profilov v vseh možnih površinskih obdelavah in vse možne kombinacije kotnih spojev in zaključkov.

GOLA PROGRAM PANEL

This panel displays every component and profile design of the Gola program, as well as possible surface finishes and combinations of corner joints and end caps.



PREZENTACIJA POVRŠINSKIH OBDELAV

Prezentacija površinskih obdelav je namenjena našim večjim partnerjem, arhitektom in oblikovalcem ter prodajnim zastopnikom. Glede na veliko količino različnih površinskih obdelav lahko iz te prezentacije natančno ocenite ustreznost in lastnosti posameznih površinskih obdelav. Na kratko so predstavljene tehnologije in skupine površinskih obdelav.

SURFACE FINISH CATALOGUE

Designed for our partners, architects, designers and sales representatives. Accurate presentation on aluminium plates allows for precise evaluation and comparison between a wide variety of surface finishes. Included is a description of every surface finish group.



PREZENTACIJA Z ALU PROFILI

Prezentacija alu profilov je namenjena našim večjim partnerjem, njihovim tehnologom, arhitektom in oblikovalcem in našim prodajnim zastopnikom. V prezentaciji so zajeti vsi aktualni profili, iz katerih so izdelani posamezni tehnični projekti.

ALUMINIUM PROFILE DESIGN COLLECTION

A collection of a large variety of recent aluminium profile extrusions. Intended for our major partners and their engineers, architects and designers, as well as our sales representatives.

rd rujzdesign

Rujz design d.o.o.
Letališka cesta 32
SI-1000 Ljubljana
Slovenija

T +386 (0)1 542 22 00
F +386 (0)1 521 12 10

info@rujzdesign.com
www.rujzdesign.com

izdajatelj/publisher
Rujz design
zasnova in oblikovanje/concept and design
Innovatif
fotografa/photographers
Aleksander Lilik, Sebastian Pelan
tisk/printed by
Kocman grafika
Ljubljana 2019

rujzdesign.com